

Form 20431  
(1151)  
Printed in U.S.A.

# LIST OF PARTS



MACHINE No. 246-2

---

\*\* A TRADE MARK OF

THE SINGER MANUFACTURING COMPANY

From the library of: Diamond Needle Corp

## INSTRUCTIONS FOR OILING

To ensure easy running and prevent unnecessary wear of the parts which are in movable contact, the machine requires oiling and when in continuous use, the oil gauge should be checked daily. The oil level should be maintained at the midpoint of the gauge.

To oil the machine, apply "TYPE A" OIL, sold only by Singer Sewing Machine Company, to the oil filler cup on top of the machine, as instructed in Form 20138.

## INDEX

	Page
<b>Accessories</b> .....	19
<b>Belt Guard (adjustable)</b> .....	19
<b>Chip Chute</b> .....	19
<b>Fittings Complete No. 164319</b> .....	15
<b>Fittings Complete No. 164346</b> .....	16
<b>Fittings Complete No. 164387</b> .....	17
<b>Fittings Complete No. 164494</b> .....	18
<b>Foot Lifter Parts</b> .....	19
<b>Machine Base</b> .....	19
<b>Machine No. 246-2</b> .....	7
<b>Numerical List of Parts</b> .....	21
<b>Thread Unwinder No. 151031</b> .....	20
<b>Thread Unwinder No. 151163</b> .....	20

From the library of: Diamond Needle Corp

## INSTRUCTIONS FOR ORDERING

In ordering from this list, use ONLY the part NUMBER in the FIRST column.

The number stamped on a Sewing Machine Part is in every case the number of the single part only.

Every combination of parts sent out as such has its specific number, which, although not stamped on the parts, must be used when ordering the combination.

Each number always indicates the SAME PART in whatever list it appears, or for whatever machine.

The letters after some of the numbers indicate the style of finish only, as follows:

- A—Hardened, Polished, Nickel Plated and Buffed
- A.A—Buffed and Chromium Plated
- A.B—Hardened, Polished, Buffed and Chromium Plated
- A.C—Brown Baking Enamel Finish
- A.D—Gray Baking Enamel Finish
- A.E—Hardened, Bright Rumbled and Nickel Plated
- A.F—Hardened, Bright Rumbled, Nickel Plated, Bright Rumbled and Chromium Plated
- A.G—Alumilite, Plain
- A.H—Alumilite, Dyed
- A.J—Polished, Nickel Plated and Chromium Plated
- A.K—Hardened, Polished, Nickel Plated and Chromium Plated
- A.L—Heat Treated for Toughness
  - B—Polished, Nickel Plated and Buffed
  - C—Hardened Only
- C.R—Hardened and Merlized
  - D—Polished Only
  - E—Soft, Not Polished
  - F—Hardened and Polished
- F.J—Hardened, Polished and Nickel Plated
- G—Bright Rumbled and Nickel Plated
- H—Blued
- J—Nickel Plated Only
- K—Hardened and Nickel Plated
- L—Brass Plated
- M—Oxidized
- N—Japanned, Dull
- P—Japanned, Bright
- P.P—Wrinkle Finish
- R—Merlized
- S—Cadmium Plated
- T—Copper Plated
- T.A—Hardened, Polished, Copper and Nickel Plated and Buffed
- T.B—Copper and Nickel Plated and Polished
- T.J—Copper and Nickel Plated Only
- T.K—Hardened, Copper and Nickel Plated
- T.L—Copper and Brass Plated
- T.M—Copper Plated and Oxidized

## INSTRUCTIONS FOR ORDERING—Continued

- U—Zinc Plated
- V—Silver Plated
- W—Polished and Nickel Plated
- X—Black Oxide, for Iron and Steel
- X.C—Hardened and Black Oxide, for Iron or Steel
- Y—Black Nickel Plated Only
- Z—Chromium Plated
- Z.A—Hardened, Polished, Nickel Plated, Buffed and Chromium Plated
- Z.B—Polished, Nickel Plated, Buffed and Chromium Plated
- Z.C—Hardened and Chromium Plated
- Z.D—Polished and Chromium Plated
- Z.G—Bright Rumbled, Nickel Plated, Bright Rumbled and Chromium Plated
- Z.J—Nickel and Chromium Plated
- Z.T—Copper and Chromium Plated

These letters MUST BE USED when they appear in the list; and AFTER the number as in the list.

In this series:

1 to 1500, 50001 to 51500 and 140001 to 142000 are Screw Numbers

1501 to 1800 and 51501 to 51800 are Nut Numbers

1801 to 2000 and 51801 to 52000 are Roller Numbers

2001 to 50000 and 52001 to 140000 and 142001 to 190000 are Sewing Machine Parts, 190001 and upward are numbers of Electrical Parts.

The figures in the second column refer only to the plates, illustrating the parts, and are NOT TO BE USED in ordering.

Parts marked with an asterisk (\*) are furnished only when repairs are made at factory.

SINGER Needles should be used  
in SINGER Machines.  
These Needles and their Containers  
are marked with the  
Company's Trade Mark "SIMANCO.\*\*\*" 1

Needles in Containers marked  
"FOR SINGER MACHINES"  
are NOT **SINGER** made needles. 2

LIST OF PARTS COMPLETE  
FOR

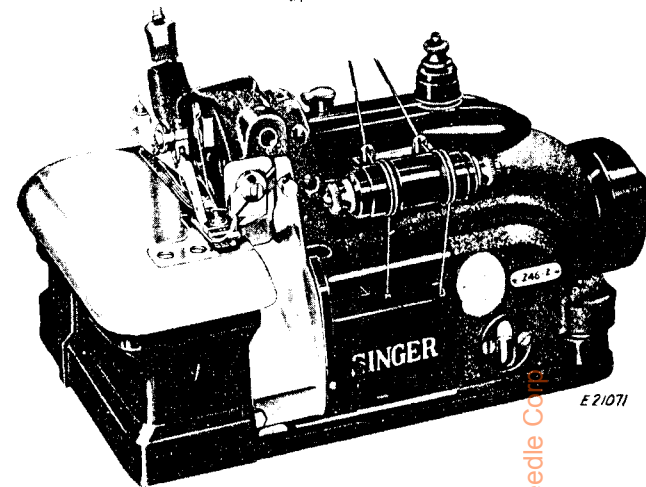

E21071

**MACHINE No. 246-2**

FOR TRIMMING AND OVEREDGING LIGHT  
AND MEDIUM WEIGHT FABRICS.  
ONE NEEDLE, TWO LOOPERS.  
TRIMMER.

SPEED UP TO 5500, DEPENDING ON MATERIALS  
USED AND OPERATIONS PERFORMED.

SINGER Needles should be used  
in SINGER Machines.  
These Needles and their Containers  
are marked with the  
Company's Trade Mark "SIMANCO.\*\*" 1

Needles in Containers marked  
"FOR SINGER MACHINES"  
are NOT **SINGER** made needles. 2

No.	Plate	Name
164001	24767	Chip Guard.....
1209J	24767	Chip Guard Screw (lower).....
140509J	24767	Chip Guard Screw (upper).....
164107	24767	Cloth Plate.....
164002	24767	Cloth Plate Extension.....
914J	24767	Cloth Plate Extension Screw (2).....
1700J	24767	Cloth Plate Extension Screw Nut.....
164205	24767	Cloth Plate Lock Spring.....
1700J	24767	Cloth Plate Lock Spring Nut.....
1250AL	24767	Cloth Plate Lock Spring Screw Stud.....
164104	24767	Cloth Plate Plunger.....
164105	24767	Cloth Plate Plunger Spring.....
624AL	24767	Cloth Plate Plunger Set Screw.....
164106	24767	Cloth Plate Position Collar with two 624AL.....
624AL	24767	Cloth Plate Position Collar Set Screw (2).....
164108	24767	Cloth Plate with Extension complete, Nos. 164002, 164107, 164205 and two each 914J and 1700J.....
164006	24797	Feed Bar with 164010.....
164017	24797	Feed Bar Connection.....

From the library of: Diamond Needle Corp.

No.	Plate	Name
164008	24797	Feed Bar Connection Bearing
164009	24797	Feed Bar Connection Hinge Screw Stud
1671C	24797	Feed Bar Connection Hinge Screw Stud Nut
164010	24797	Feed Bar Connection Hinge Screw Stud Nut Position Pin
164277	24797	Feed Bar Guide (roller)
164003	24797	Feed Bar Hinge Pin (eccentric)
1389C	24797	Feed Bar Hinge Pin Set Screw
164004	24797	Feed Bar Slide Block (back)
1628C	24797	Feed Bar Slide Block (back) Nut
17022	24797	Feed Bar Slide Block (back) Nut Washer
164005	24797	Feed Bar Slide Block (front)
164278	24797	Feed Bar Spacing Collar
164276		Feed Bar complete, Nos. 1671C, 164004, 164005, 164006, 164008, 164009 and 164017
164318	24800	Feed Dog, 21 teeth (16 teeth to the inch)
1454F	24800	Feed Dog Screw
164020	24797	Feed Eccentric
NOTE: Feed Eccentric No. 164020 is furnished in 4 to 16, 18, 20, 22, 24, 28, 32 and 36 stitches to the inch, unless otherwise stated No. 164020 (5 stitches to the inch) is supplied regularly.		
164398	24797	Feed Eccentric Cover
164400	24797	Feed Eccentric Cover Bracket with 164345
157C	24797	Feed Eccentric Cover Bracket Screw
629K	24797	Feed Eccentric Cover Hinge Screw
164401	24797	Feed Eccentric Cover Latch Spring
227J	24797	Feed Eccentric Cover Latch Spring Screw (2)
164403	24797	Feed Eccentric Cover complete, Nos. 629K, 164398, 164400, 164401 and two 227J
164345	24797	Feed Eccentric Oil Wick
164025	24755	Feed Lifting and Knife (movable) Eccentric
164026	24798	Knife (movable)
164507	24798	Knife (movable) Clamp and Guard
140050C	24798	Knife (movable) Clamp Screw
164029	24798	Knife (movable) Holder
198J	24798	Knife (movable) Holder Screw
164030	24798	Knife (movable) Holder Screw Bearing
164031	24798	Knife (movable) Lever with 620AL
164211		Knife (movable) Lever 164031 with 132583, 164035, 164136 and 164153
164032	24798	Knife (movable) Lever Bearing
50421AL	24798	Knife (movable) Lever Bearing Set Screw (long)
624AL	24798	Knife (movable) Lever Bearing Set Screw (short)
164246	24770	Knife (movable) Lever Cover and Presser Bar (upright) Housing
50073J	24770	Knife (movable) Lever Cover and Presser Bar (upright) Housing Screw (2)
164247		Knife (movable) Lever Cover and Presser Bar (upright) Housing complete, Nos. 50060K, 164137, 164138, 164139, 164142, 164143, 164144, 164194 and 164246
164180	24798	Knife (movable) Lever Guide
164181	24798	Knife (movable) Lever Guide Holder with two 140239AL
164210	24798	Knife (movable) Lever Guide Holder 164181 with 197J, 164177, 164180 and 164182
140239AL	24798	Knife (movable) Lever Guide Holder Set Screw (2)
164182	24798	Knife (movable) Lever Guide Holder Thread Tube
50421AL	24798	Knife (movable) Lever Guide Holder Thread Tube Set Screw
197J	24798	Knife (movable) Lever Guide Screw
132583	24798	Knife (movable) Lever Hinge Pin with 132584
132584	24798	Knife (movable) Lever Hinge Pin Oil Wick
620AL	24798	Knife (movable) Lever Hinge Pin Set Screw
164034	24798	Knife (movable) Lever Hinge Stud
164035		Knife (movable) Lever Hinge Stud 164034 with 164036 and 164269

No.	Plate	Name
164036	24798	Knife (movable) Lever Hinge Stud Oil Wick (long)
164269		Knife (movable) Lever Hinge Stud Oil Wick (short)
50421AL	24798	Knife (movable) Lever Hinge Stud Set Screw (back)
1143AL	24798	Knife (movable) Lever Hinge Stud Set Screw (top)
164233	24798	Knife (stationary)
164522	24798	Knife (stationary) Clamping Stud
164523	24798	Knife (stationary) Clamping Stud Nut
164524	24798	Knife (stationary) Holder
164040	24798	Knife (stationary) Holder Adjusting Stud
1454E	24798	Knife (stationary) Holder Adjusting Stud Cap Screw
39541	24798	Knife (stationary) Holder Adjusting Stud Cap Screw Washer
164042	24798	Knife (stationary) Holder Sleeve
140088R	24798	Knife (stationary) Holder Sleeve Screw
59456	24798	Knife (stationary) Holder Sleeve Screw Washer
164043	24798	Knife (stationary) Holder Spring
164525	24798	Knife (stationary) Holder Spring Stud
164462	24798	Lint Stripper with 735AL
735AL	24798	Lint Stripper Set Screw
164045	24799	Looper (left hand)
164046	24799	Looper (left hand) Carrier with 460AL, 50379F and 164202
164047	24799	Looper (left hand) Carrier Holder with 140393AL and 140596AL
164212		Looper (left hand) Carrier Holder 164047 with 1324C, 59456 and 164046
140596AL		Looper (left hand) Carrier Holder Set Screw (left)
140393AL	24799	Looper (left hand) Carrier Holder Set Screw (right)
1324C	24799	Looper (left hand) Carrier Screw
460AL	24799	Looper (left hand) Carrier Screw Set Screw
59456	24799	Looper (left hand) Carrier Screw Washer
164048	24799	Looper (left hand) Driving Shaft
164049	24799	Looper (left hand) Driving Shaft Bushing (back)
140394E	24799	Looper (left hand) Driving Shaft Bushing (back) Cap Screw
164293	24799	Looper (left hand) Driving Shaft Bushing (back) Cap Screw Washer (fiber)
164050	24799	Looper (left hand) Driving Shaft Bushing (front)
164051	24799	Looper (left hand) Driving Shaft Crank with 1083C
164215		Looper (left hand) Driving Shaft Crank 164051 with 164052
1083C	24799	Looper (left hand) Driving Shaft Crank Clamping Screw
164052	24755	Looper (left hand) Driving Shaft Crank Connection with two each 171AL and 140159AL
171AL	24755	Looper (left hand) Driving Shaft Crank Connection Cap (lower) Screw (2)
140159AL	24755	Looper (left hand) Driving Shaft Crank Connection Cap (upper) Screw (2)
164067	24799	Looper (left hand) Driving Shaft Crank Key
1324C	24799	Looper (left hand) Driving Shaft Crank Key Screw
45057	24799	Looper (left hand) Driving Shaft Crank Key Screw Washer
164053	24799	Looper (left hand) Driving Shaft Crank Thrust Bearing
50379F	24799	Looper (left hand) Set Screw
164202	24799	Looper (left hand) Stop Pin
164054	24800	Looper (left hand) Thread Tube
853AL	24800	Looper (left hand) Thread Tube Set Screw
164055	24799	Looper (right hand)
164056	24799	Looper (right hand) Carrier with 50370E
164057	24799	Looper (right hand) Carrier Connection
164058	24799	Looper (right hand) Carrier Connection Guide Bar with 624AL and 168215
168215		Looper (right hand) Carrier Connection Guide Bar Oil Wick
624AL	24799	Looper (right hand) Carrier Connection Guide Bar Plug Screw

No.	Plate	Name
164463	24799	Looper (right hand) Carrier Connection Guide Bar Bracket with 164060 and two 462AL
164060	24799	Looper (right hand) Carrier Connection Guide Bar Bracket Oil Pad
914C	24799	Looper (right hand) Carrier Connection Guide Bar Bracket Screw (left)
1057AL	24799	Looper (right hand) Carrier Connection Guide Bar Bracket Screw (right)
462AL	24799	Looper (right hand) Carrier Connection Guide Bar Set Screw (2)
164061	24799	Looper (right hand) Carrier Connection Hinge Stud with 1019AL
1443J	24799	Looper (right hand) Carrier Connection Hinge Stud Cap Screw
164397	24799	Looper (right hand) Carrier Connection Hinge Stud Adjusting Pin
1019AL	24799	Looper (right hand) Carrier Connection Hinge Stud Adjusting Pin Set Screw
132565	24799	Looper (right hand) Carrier Hinge Pin
50370E	24799	Looper (right hand) Carrier Hinge Pin Set Screw
164062	24799	Looper (right hand) Driving Lever with 1083C and two 140596AL
164464		Looper (right hand) Driving Lever 164062 with 1443J, 1700J, 132565, 164056, 164057, 164058, 164061, 164068, 164397 and 164463
1083C	24799	Looper (right hand) Driving Lever Clamping Screw
140596AL	24799	Looper (right hand) Driving Lever Set Screw (2)
164063	24799	Looper (right hand) Driving Shaft
164049	24799	Looper (right hand) Driving Shaft Bushing (back)
140394E	24799	Looper (right hand) Driving Shaft Bushing (back) Cap Screw
164293	24799	Looper (right hand) Driving Shaft Bushing (back) Cap Screw Washer (fiber)
164065	24799	Looper (right hand) Driving Shaft Bushing (front)
164066	24799	Looper (right hand) Driving Shaft Crank with 1083C
164216		Looper (right hand) Driving Shaft Crank 164066 with 164052
1083C	24799	Looper (right hand) Driving Shaft Crank Clamping Screw
164052	24755	Looper (right hand) Driving Shaft Crank Connection with two each 171AL and 140159AL
171AL	24755	Looper (right hand) Driving Shaft Crank Connection Cap (lower) Screw (2)
140159AL	24755	Looper (right hand) Driving Shaft Crank Connection Cap (upper) Screw (2)
164067	24799	Looper (right hand) Driving Shaft Crank Key
1324C	24799	Looper (right hand) Driving Shaft Crank Key Screw
45057	24799	Looper (right hand) Driving Shaft Crank Key Screw Washer
164053	24799	Looper (right hand) Driving Shaft Crank Thrust Bearing
164068	24799	Looper (right hand) Locking Screw Stud
17001	24799	Looper (right hand) Locking Screw Stud Nut
164219	24799	Looper (right hand) Position Collar with 904E
904E	24799	Looper (right hand) Position Collar Set Screw
*164072		Machine Frame
*164526		Machine Frame complete, Nos. 140396E, 164072, 164077, 164528 and three 140395C
164074	24756	Machine Frame Bottom Cover
164075	24756	Machine Frame Bottom Cover Gasket
914C	24756	Machine Frame Bottom Cover Screw (13)
*164527		Machine Frame Bracket
*164528		Machine Frame Bracket 164527 with 164207 and two 187E
164207	24759	Machine Frame Bracket Key
187E	24759	Machine Frame Bracket Key Screw (2)

No.	Plate	Name
140396E	24759	Machine Frame Bracket Screw (large)
164077	24759	Machine Frame Bracket Screw (large) Washer (fiber)
164229	24759	Machine Frame Bracket Screw (large) Washer (felt)
140395C	24759	Machine Frame Bracket Screw (small) (3)
164078	24756	Machine Frame Cover (back)
50571J	24756	Machine Frame Cover (back) Screw (long) (2)
914J	24756	Machine Frame Cover (back) Screw (short)
164079	24756	Machine Frame Cover (back) Slide
140200J	24756	Machine Frame Cover (back) Slide Position Screw
238J	24756	Machine Frame Cover (back) Slide Stop Screw
164080	24756	Machine Frame Cover (back) complete, Nos. 238J, 1637K, 140200J, 140228C, 164078 and 164079
164081	24759	Machine Frame Oil Lead
140088R	24759	Machine Frame Oil Lead Screw
1698J	24759	Machine Frame Oil Lead Screw Nut
164082	24759	Machine Frame Oil Plug Bracket
1036AL	24759	Machine Frame Oil Plug Bracket Set Screw
164083	24759	Machine Frame Oil Screen
206J	24759	Machine Frame Oil Screen Screw (3)
164084	24759	Machine Frame Oil Splash Guard (internal)
164085	24770	Machine Frame Oil Splash Guard (top)
51023W	24770	Machine Frame Oil Splash Guard (top) Screw (2)
164086	24759	Machine Frame Oil Tube with 164087
50421AL	24759	Machine Frame Oil Tube Set Screw
164087	24759	Machine Frame Oil Tube Wick
164461		Machine Frame Oil Tube Wick Retainer
164088	24755	Machine Frame Plug
164089	24755	Machine Frame Rotary Shaft
164090		Machine Frame Rotary Shaft 164089 with 164097, 164215, 164216, 164217 and two each 164093 and 164232
139026	24755	Machine Frame Rotary Shaft Ball Bearing
164092	24755	Machine Frame Rotary Shaft Ball Bearing Housing
51369C	24755	Machine Frame Rotary Shaft Ball Bearing Housing Screw (3)
164093	24755	Machine Frame Rotary Shaft Ball Sleeve (two pieces) (2)
164232	24755	Machine Frame Rotary Shaft Ball Sleeve Guide (2)
164094	24755	Machine Frame Rotary Shaft Bushing (front)
1036AL	24755	Machine Frame Rotary Shaft Bushing (front) Set Screw
164095	24755	Machine Frame Rotary Shaft Bushing (intermediate)
51332C	24755	Machine Frame Rotary Shaft Bushing (intermediate) Set Screw
164096	24755	Machine Frame Rotary Shaft Counterbalance with 1036AL
1036AL	24755	Machine Frame Rotary Shaft Counterbalance Set Screw
164097	24755	Machine Frame Rotary Shaft Key
51649C	24755	Machine Frame Rotary Shaft Nut
131056	24755	Machine Frame Rotary Shaft Nut Washer
164098	24755	Machine Frame Rotary Shaft Oil Sling and Ball Bearing Grease Retainer
164099	24755	Machine Frame Rotary Shaft Screw Stud
164100	24755	Machine Frame Rotary Shaft Thrust Bearing
164101	24772	Machine Frame Top Cover
164214		Machine Frame Top Cover 164101 with 330J, 164103 and two 164418
164102	24772	Machine Frame Top Cover Gasket
164103	24772	Machine Frame Top Cover Oil Lead
330J	24772	Machine Frame Top Cover Oil Lead Screw
51369J	24772	Machine Frame Top Cover Screw (3)
164231	24755	Machine Pulley (round and "V" belt) with two 448AL
164071	24755	Machine Pulley Cap
140416X	24755	Machine Pulley Cap Screw
448AL	24755	Machine Pulley Set Screw (2)
164109	24770	Needle Clamp
51720C	24770	Needle Clamping Nut

If you are having trouble finding a part, please call 1-800-4-A-Parts.



No.	Plate	Name
164110	24770	Needle Driving Shaft with 164118
164275	.....	Needle Driving Shaft 164110 with 51720C, 164109 and 164117
164111	24770	Needle Driving Shaft Bushing
164112	24770	Needle Driving Shaft Bushing Cap
164113	24770	Needle Driving Shaft Bushing Oil Lead
452C	24770	Needle Driving Shaft Bushing Oil Lead Hole Plug Screw
164114	24770	Needle Driving Shaft Crank with 1083C and two 140596AL
164115	24770	Needle Driving Shaft Crank Ball
1083C	24770	Needle Driving Shaft Crank Clamping Screw
164116	24755	Needle Driving Shaft Crank Connection with two each 171AL and 896AL
164217	.....	Needle Driving Shaft Crank Connection 164116 with 164115
896AL	24755	Needle Driving Shaft Crank Connection Cap (lower) Screw (2)
171AL	24755	Needle Driving Shaft Crank Connection Cap (upper) Screw (2)
140596AL	24770	Needle Driving Shaft Crank Set Screw (2)
164117	24770	Needle Holder
164118	24770	Needle Stop Pin
164119	24755	Oil Agitator
164120	24759	Oil Cooler with two 164125
164121	24759	Oil Cooler Cover
164123	24759	Oil Cooler Cover 164121 with 164135
164122	24759	Oil Cooler Cover Gasket
145J	24759	Oil Cooler Cover Screw
164124	24759	Oil Cooler Gasket
164125	24759	Oil Cooler Oil Pipe (outlet) (2)
164126	24759	Oil Cooler Oil Tube with 138269 and 164128
164127	24759	Oil Cooler Oil Tube Coupling
51630	24759	Oil Cooler Oil Tube Lock Nut
138269	24759	Oil Cooler Oil Tube Sleeve
164128	24759	Oil Cooler Oil Tube Wick
51139J	24759	Oil Cooler Screw (long) (2)
1324J	24759	Oil Cooler Screw (short)
164131	24759	Oil Sight Gauge Background Disc
164132	24759	Oil Sight Gauge Background Disc Gasket
164133	24759	Oil Sight Gauge Window
164132	24759	Oil Sight Gauge Window Gasket
164134	24759	Oil Sight Gauge Window Retainer
164132	24759	Oil Sight Gauge Window Retainer Gasket
1485J	24759	Oil Sight Gauge Window Retainer Screw (2)
164135	24759	Oil Cup for filling machine
164136	24798	Presser Bar Bracket
164137	24770	Presser Bar Lifting Bracket with 462AL, 624AL and 51846
51846	24770	Presser Bar Lifting Bracket Roller and Stud
624AL	24770	Presser Bar Lifting Bracket Set Screw (long)
462AL	24770	Presser Bar Lifting Bracket Set Screw (short)
164138	24770	Presser Bar Lifting Lever
164139	24770	Presser Bar Lifting Lever Spring
140228C	24756	Presser Bar Lifting Lever Stop Screw
1637K	24756	Presser Bar Lifting Lever Stop Screw Nut
164350	24798	Presser Bar (swing-out)
164141	24798	Presser Bar (swing-out) Lifting Screw Stud
1700J	24798	Presser Bar (swing-out) Lifting Screw Stud Nut
164142	24770	Presser Bar (swing-out) Opening Lever
50060K	24770	Presser Bar (swing-out) Opening Lever Hinge Screw
140510C	24798	Presser Bar (swing-out) Pivot Screw
164351	24798	Presser Bar (swing-out) Pivot Screw Lock Washer
51362AL	24798	Presser Bar (swing-out) Pivot Screw Lock Washer Screw
164143	24770	Presser Bar (upright)

No.	Plate	Name
164144	24770	Presser Bar (upright) Spring
164416	.....	Presser Bar (upright) Spring (heavy)
164145	24800	Presser Foot Body
164220	24800	Presser Foot Chain Cutter Friction Plate
164221	24800	Presser Foot Chain Cutter Knife
51306E	24800	Presser Foot Chain Cutter Knife Screw
164146	24800	Presser Foot Chaining-off Finger
164147	24800	Presser Foot Clamping Plate
50225J	24800	Presser Foot Clamping Plate Screw
164149	24800	Presser Foot Guide
50169J	24800	Presser Foot Guide Screw
164150	24800	Presser Foot with Chain Cutter complete, Nos. 50169J, 50225J, 51306E, 164145, 164146, 164147, 164149, 164220 and 164221
164317	24800	Presser Bar (swing-out) with Presser Foot complete, Nos. 1700J, 164141, 164150 and 164350
164194	24770	Pressure Regulating Thumb Screw
2102	24772	Tension (heavy) Disc (4)
164155	24772	Tension (heavy) Regulating Thumb Nut (2)
50133C	24772	Tension (heavy) Screw Stud (2)
164156	.....	Tension (heavy) Screw Stud 50133C with 164155 (2)
164161	24772	Tension (heavy) Spring (2)
59537	24772	Tension (heavy) Spring Bushing (2)
164158	24772	Tension (heavy) Spring Cover (2)
164162	24772	Tension (heavy) complete, Nos. 59537, 164156, 164158, 164161 and two 2102 (2)
2102	24772	Tension (light) Disc (2)
164155	24772	Tension (light) Regulating Thumb Nut
50133C	24772	Tension (light) Screw Stud
164156	.....	Tension (light) Screw Stud 50133C with 164155
164157	24772	Tension (light) Spring
59537	24772	Tension (light) Spring Bushing
164158	24772	Tension (light) Spring Cover
164160	24772	Tension (light) complete, Nos. 59537, 164156, 164157, 164158 and two 2102
164285	24772	Tension (looper thread) Thread Guide (left)
164286	24772	Tension (looper thread) Thread Guide (right)
164159	24772	Tension (needle thread) Thread Guide
164418	24772	Tension Thread Eyelet (2)
164091	24799	Thread (looper, right hand) Stripper and Take-up
164163	24761	Thread (looper, right hand) Stripper and Take-up Eyelet (adjustable)
1443J	24761	Thread (looper, right hand) Stripper and Take-up Eyelet (adjustable) Screw
187E	24799	Thread (looper, right hand) Stripper and Take-up Screw
17022	24799	Thread (looper, right hand) Stripper and Take-up Screw Washer
164164	24761	Thread (looper, right hand) Thread Eyelet (movable)
1423J	24761	Thread (looper, right hand) Thread Eyelet Screw
164165	24761	Thread (looper, right hand) Thread Eyelet (stationary)
1607J	24761	Thread (looper, right hand) Thread Eyelet (stationary) Nut
164166	24761	Thread (looper, right hand) Tube
624AL	24761	Thread (looper, right hand) Tube Set Screw
164167	24761	Thread (looper) Plate with 624AL
164168	24761	Thread (looper) Plate Cover
164206	.....	Thread (looper) Plate Cover 164168 with 164169 and 164170
164169	24761	Thread (looper) Plate Cover Hinge
164170	24761	Thread (looper) Plate Cover Hinge Pin
164171	24761	Thread (looper) Plate Cover Spring (2)
332J	24761	Thread (looper) Plate Cover Spring Screw (2)
896AL	24761	Thread (looper) Plate Screw (2)
164173	24761	Thread (looper) Plate Thread Bushing

No.	Plate	Name
50318W	24761	Thread (looper) Plate Thread Bushing Screw
164174	.....	Thread (looper) Plate complete, Nos. 1423J, 1443J, 1607J, 50318W, 164163, 164164, 164165, 164166, 164167, 164173, 164206 and two each 332J and 164171
164175	24799	Thread (looper) Take-up (left)
164176	24799	Thread (looper) Take-up Plate
176E	24799	Thread (looper) Take-up Screw (lower)
1443J	24799	Thread (looper) Take-up Screw (upper)
164151	24798	Thread (needle) Controller
164153	24798	Thread (needle) Controller Lever
1443J	24798	Thread (needle) Controller Screw
164177	24798	Thread Eyelet (needle thread)
140239AL	24798	Thread Eyelet (needle thread) Set Screw
164228	24800	Throat Plate
164179	24800	Throat Plate Guide with 853AL
1454E	24800	Throat Plate Guide Screw
1094F	24800	Throat Plate Screw (2)

SINGER Needles should be used  
in SINGER Machines.  
These Needles and their Containers  
are marked with the  
Company's Trade Mark "SIMANCO.\*\*" 1

Needles in Containers marked  
"FOR SINGER MACHINES"  
are NOT **SINGER** made needles. 2

SET OF FITTINGS COMPLETE No. 164319  
FOR SEWING POCKETS AND PILLOW CASES  
FOR THREE-THREAD STITCH

NOTE: Set of Fittings No. 164319 is regular to machine, unless otherwise stated on machine order.

No.	Plate	Name
164318	24802	Feed Dog, 21 teeth (16 teeth to the inch)
164026	24802	Knife (movable)
164055	24802	Looper (right hand)
164350	24802	Presser Bar (swing-out)
164141	24802	Presser Bar (swing-out) Lifting Screw Stud
1700J	24802	Presser Bar (swing-out) Lifting Screw Stud Nut
164145	24802	Presser Foot Body
164220	24802	Presser Foot Chain Cutter Friction Plate
164221	24802	Presser Foot Chain Cutter Knife
51306E	24802	Presser Foot Chain Cutter Knife Screw
164146	24802	Presser Foot Chaining-off Finger
164147	24802	Presser Foot Clamping Plate
50225J	24802	Presser Foot Clamping Plate Screw
164149	24802	Presser Foot Guide
50169J	24802	Presser Foot Guide Screw
164150	24802	Presser Foot with Chain Cutter complete, Nos. 50169J, 50225J, 51306E, 164145, 164146, 164147, 164149, 164220 and 164221
164317	24802	Presser Bar (swing-out) with Presser Foot complete, Nos. 1700J, 164141, 164150 and 164350
164175	24802	Thread (looper) Take-up
164091	24802	Thread (looper, right hand) Stripper and Take-up
164151	24802	Thread (needle) Controller
164228	24802	Throat Plate
164179	24802	Throat Plate Guide with 853AL
164319	24802	Set of Fittings complete, Nos. 164026, 164055, 164091, 164151, 164175, 164179, 164228, 164317 and 164318

From the library of Diana M. Neale, Corp.



SET OF FITTINGS COMPLETE No. 164346  
FOR SEWING INTERLINING AND LINING TOGETHER  
FOR TWO-THREAD STITCH

No.	Plate	Name
164295	24803	Feed Dog, 18 teeth (12 teeth to the inch)
164308	24803	Knife (movable)
164252	24803	Spreader
164381	24803	Thread (needle) Controller
164346	24803	Set of Fittings complete, Nos. 164252, 164295, 164308 and 164381
NOTE: When using Set of Fittings complete No. 164346, the following parts which are not included in this Set of Fittings, are necessary, if machine has previously been fitted other than regular (see Set of Fittings 164319)		
164350	24803	Presser Bar (swing-out)
164141	24803	Presser Bar (swing-out) Lifting Screw Stud
1700J	24803	Presser Bar (swing-out) Lifting Screw Stud Nut
164145	24803	Presser Foot Body
164220	24803	Presser Foot Chain Cutter Friction Plate
164221	24803	Presser Foot Chain Cutter Knife
51306E	24803	Presser Foot Chain Cutter Knife Screw
164146	24803	Presser Foot Chaining-off Finger
164147	24803	Presser Foot Clamping Plate
50225J	24803	Presser Foot Clamping Plate Screw
164149	24803	Presser Foot Guide
50169J	24803	Presser Foot Guide Screw
164150	24803	Presser Foot with Chain Cutter complete, Nos. 50169J, 50225J, 51306E, 164145, 164146, 164147, 164149, 164220 and 164221
164317	24803	Presser Bar (swing-out) with Presser Foot complete, Nos. 1700J, 164141, 164150 and 164350
164091	24803	Thread (looper) Stripper and Take-up
164175	24803	Thread (looper) Take-up
164228	24803	Throat Plate
164179	24803	Throat Plate Guide with 853AL

SINGER Needles should be used  
in SINGER Machines.  
These Needles and their Containers  
are marked with the  
Company's Trade Mark "SIMANCO.\*\*\*" 1.

Needles in Containers marked  
"FOR SINGER MACHINES"  
are NOT **SINGER** made needles. 2

SET OF FITTINGS COMPLETE No. 164387  
FOR DRESS SHIELDS  
FOR THREE-THREAD PURL-ON-EDGE STITCH

No.	Plate	Name
164279	24804	Feed Dog Section (left)
164280	24804	Feed Dog Section (right)
1100AL	24804	Feed Dog Section (right) Screw
164281	24804	Feed Dog complete, Nos. 1100AL, 164279 and 164280
164258	24804	Presser Bar (swing-out)
164282	24804	Presser Foot Chaining-off Finger
164263	24804	Presser Foot Clamping Plate
50225J	24804	Presser Foot Clamping Plate Screw
164283	24804	Presser Foot Plate
164284	24804	Presser Foot complete, Nos. 50225J, 164263, 164282 and 164283
140180J	24804	Presser Foot Screw
164381	24804	Thread (needle) Controller
164290	24804	Throat Plate
164268	24804	Throat Plate Guide with 853AL
164387	24804	Set of Fittings complete, Nos. 140180J, 164258, 164268, 164281, 164284, 164290 and 164381
NOTE: When using Set of Fittings complete No. 164387, the following parts which are not included in this Set of Fittings, are necessary, if machine has previously been fitted other than regular (see Set of Fittings 164319).		
164026	24804	Knife (movable)
164055	24804	Looper (right hand)
164175	24804	Thread (looper) Take-up (left)
164091	24804	Thread (looper) Take-up (right)

## SET OF FITTINGS COMPLETE No. 164494

## FOR PANTS SERGING FOR LIGHT

## AND MEDIUM OR HEAVY-WEIGHT FABRICS,

## FOR TWO-THREAD STITCH, 1/4 IN. BIGHT

No.	Plate	Name
164469	24805	Feed Dog
164530	24805	Guide (swing-out)
164297	24805	Guide (swing-out) Arm
164298	24805	Guide (swing-out) Arm Holder
50267R	24805	Guide (swing-out) Arm Holder Screw (2)
164541	24805	Guide (swing-out) Arm Lock Spring
1423J	24805	Guide (swing-out) Arm Lock Spring Screw
1550J	24805	Guide (swing-out) Arm Lock Spring Screw Nut
164502	24805	Guide (swing-out) Extension (lower)
164299	24805	Guide (swing-out) Extension (upper)
197J	24805	Guide (swing-out) Extension Screw
164503		Guide (swing-out) with Extensions complete, Nos. 197J, 164299, 164502 and 164530
1425J	24805	Guide (swing-out) Hinge Screw
42436	24805	Guide (swing-out) Hinge Screw Washer
1443J	24805	Guide (swing-out) Screw (2)
164311	24805	Guide (swing-out) with Arm and Holder complete, Nos. 1423J, 1425J, 1550J, 42436, 164297, 164298, 164503, 164541 and two 1443J
164308	24805	Knife (movable)
164492	24805	Machine Frame Oil Splash Guard (top)
164471	24805	Presser Foot Body
164438	24805	Presser Foot Chaining-off Finger for 164474
164146	24805	Presser Foot Chaining-off Finger for 164475
164147	24805	Presser Foot Clamping Plate
50225J	24805	Presser Foot Clamping Plate Screw
164303	24805	Presser Foot Guide
51229J	24805	Presser Foot Guide Screw
164474	24805	Presser Foot complete, for light and medium fabrics, Nos. 50225J, 51229J, 164146, 164147, 164303, 164438 and 164471
164475	24805	Presser Foot complete, for heavy-weight fabrics, Nos. 50225J, 51229J, 164146, 164147, 164303 and 164471
164476	24805	Presser Foot Thread Chain Guard
140180J	24805	Presser Foot Thread Chain Guard Screw
164252	24805	Spreader
164381	24805	Thread (needle) Controller
164440	24805	Throat Plate
164494	24805	Set of Fittings complete, Nos. 140180J, 164252, 164308, 164311, 164381, 164440, 164469, 164474 or 164475, 164476, 164492 and two 50267R
NOTE: When using Set of Fittings complete No. 164494, the following parts which are not included in this Set of Fittings, are necessary, if machine has previously been fitted other than regular (see Set of Fittings No. 164319)		
164350	24805	Presser Bar (swing-out)
164091	24805	Thread (looper) Stripper and Take-up
164175	24805	Thread (looper) Take-up
164179	24805	Throat Plate Guide with 853AL

## ACCESSORIES

No.	Plate	Name
164203	24801	Feed Eccentric Extractor (Not regularly furnished with machine)
164459	24801	Gauge (Not regularly furnished with machine)
160725	24801	Oil Container
160727	24801	Oil Container (filled, 5 oz. mfg. oil, light grade, not stainless) Nos. 160725 and 160726
160726	24801	Oil Container Cap
160728	24801	Oil Container Spout, for use when filling Oil Reservoir
164198	24801	Presser Bar Lifting Chain Spring (under table)
26026	24801	Screw Driver
164196	24801	Threader (6)
164204	24801	Tweezers
164197	24801	Wrench (socket)
10875		Wrench (flat) for 1701 and 51649

## BELT GUARD (Adjustable)

164183	24763	Belt Guard
164199	24763	Belt Guard Bracket (back)
164200	24763	Belt Guard Bracket (front)
51326J	24763	Belt Guard Screw (2)
164201	24763	Belt Guard (adjustable) complete, Nos. 164183, 164199, 164200 and two each 51326J and wood screws 3/4 in. No. 7 F.H.

## CHIP CHUTE

168198	24763	Chip Chute with four wood screws 3/8 in. No. 6 R.H. blacked
--------	-------	---

## FOOT LIFTER PARTS

6439	24763	Chain, 36 in. to 45 in. with 56864 and 56865
NOTE: When ordering No. 6439, give length required		
4879	24763	Chain Connecting Link
56864	24763	Chain Hook (large)
56865	24763	Chain Hook (small)
4881	24763	Treadle
4882	24763	Treadle Shaft
4883		Treadle Spring
4884	24763	Treadle Stand
4885	24763	Treadle complete, Nos. 4879, 4881, 4882, 4883, 4884 and two wood screws 1 in. No. 16 F.H.

## MACHINE BASE

164184	24763	Machine Base with 50608R, 139017 and two each wood screws 3/4 in. No. 8 R.H. and 1 1/4 in. No. 6 F.H.
50608R	24763	Machine Base Plug Screw
139017	24763	Machine Base Plug Screw Washer
164188	24763	Machine Cushion (large) (2)
164189	24763	Machine Cushion (small) (2)
164190	24763	Machine Pad (felt)
140418E	24755	Machine Screw Stud (back)
657E	24755	Machine Screw Stud (front)

**THREAD UNWINDER No. 151031  
FOR THREE SPOOLS**

No.	Plate	Name
228692		Spool Pin (3)
201528		Spool Pin Nut (3)
395243		Spool Pin Washer (3)
151023	24764	Spool Rest with 858AL and three each 201528, 228692 and 395243
150203	24764	Spool Rest Cushion (felt) (3)
858AL	24764	Spool Rest Hub Set Screw
151024	24764	Spool Rest Rod
1122C	24764	Spool Rest Rod Set Screw (2)
151025	24764	Spool Rest Stand with two 1122C and three wood screws 1 in. No. 12 F.H.
151026	24764	Thread Guide (lower)
50311C	24764	Thread Guide (lower) Holder Set Screw
151027	24764	Thread Guide (lower) Support with 50311C
151028	24764	Thread Guide (upper, hollow) (2)
151029	24764	Thread Guide (upper) Holder with four 453AL
453AL	24764	Thread Guide Set Screw (3)
151030	24764	Thread Guide Rod
453AL	24764	Thread Guide Rod Set Screw
151031	24764	Thread Unwinder complete, Nos. 151023, 151024, 151025, 151026, 151027, 151029, 151030, two 151028 and three 150203

**THREAD UNWINDER No. 151163  
FOR FOUR SPOOLS**

228692	24806	Spool Pin
201528X		Spool Pin Nut
228693		Spool Pin Washer for 225259
395243		Spool Pin Washer for 151023 (3)
151023	24806	Spool Rest with 858AL and three each 201528, 228692 and 395243 (three spools)
225259	24806	Spool Rest with 201018C, 201528X, 228692 and 228693 (one spool)
150203	24806	Spool Rest Cushion (felt) (4)
858AL	24806	Spool Rest Hub Set Screw for 151023
151024	24806	Spool Rest Rod
1122C	24806	Spool Rest Rod Set Screw (2)
201018C	24806	Spool Rest Set Screw for 225259
151025	24806	Spool Rest Stand with two 1122C and three wood screws 1 in. No. 12 F.H.
151026	24806	Thread Guide (lower)
50311C	24806	Thread Guide (lower) Holder Set Screw
151027	24806	Thread Guide (lower) Support with 50311C
151028	24806	Thread Guide (upper, hollow) (2)
151162	24806	Thread Guide (upper, solid)
151029	24806	Thread Guide (upper) Holder with four 453AL
453AL	24806	Thread Guide Set Screw (3)
151030	24806	Thread Guide Rod
453AL	24806	Thread Guide Rod Set Screw
151163	24806	Thread Unwinder complete, Nos. 151023, 151024, 151025, 151026, 151027, 151029, 151030, 151162, 225259, two 151028 and four 150203

**NUMERICAL LIST OF PARTS**

No.	Plate	Name
145J	24759	Oil Cooler Cover Screw
157C	24797	Feed Eccentric Cover Bracket Screw
171AL	24755	Looper (left hand) Driving Shaft Crank Connection Cap (lower) Screw for 164052 (2)
171AL	24755	Looper (right hand) Driving Shaft Crank Connection Cap (lower) Screw for 164052 (2)
171AL	24755	Needle Driving Shaft Crank Connection Cap (upper) Screw for 164116 (2)
176E	24799	Thread (looper) Take-up Screw (lower)
187E	24759	Machine Frame Bracket Key Screw for 164528 (2)
187E	24799	Thread (looper, right hand) Stripper and Take-up Screw
197J	24805	Guide (swing-out) Extension Screw for 164503
197J	24798	Knife (movable) Lever Guide Screw for 164210
198J	24798	Knife (movable) Holder Screw
206J	24759	Machine Frame Oil Screen Screw (3)
227J	24797	Feed Eccentric Cover Latch Spring Screw for 164403 (2)
238J	24756	Machine Frame Cover (back) Slide Stop Screw for 164080
330J	24772	Machine Frame Top Cover Oil Lead Screw for 164214
332J	24761	Thread (looper) Plate Cover Spring Screw for 164174 (2)
448AL	24755	Machine Pulley Set Screw for 164231 (2)
452C	24770	Needle Driving Shaft Bushing Oil Lead Hole Plug Screw
453AL	24764	Thread Unwinder Thread Guide Rod Set Screw for 151029
453AL	24764	Thread Unwinder Thread Guide Set Screw for 151029 (3)
460AL	24799	Looper (left hand) Carrier Screw Set Screw for 164046
462AL	24799	Looper (right hand) Carrier Connection Guide Bar Set Screw for 164463 (2)
462AL	24770	Presser Bar Lifting Bracket Set Screw (short) for 164137
620AL	24798	Knife (movable) Lever Hinge Pin Set Screw for 164031
624AL	24767	Cloth Plate Plunger Set Screw
624AL	24767	Cloth Plate Position Collar Set Screw for 164106 (2)
624AL	24798	Knife (movable) Lever Bearing Set Screw (short)
624AL	24799	Looper (right hand) Carrier Connection Guide Bar Plug Screw for 164058
624AL	24770	Presser Bar Lifting Bracket Set Screw (long) for 164137
624AL	24761	Thread (looper, right hand) Tube Set Screw for 164167
629K	24797	Feed Eccentric Cover Hinge Screw for 164403
657E	24755	Machine Screw Stud (front)
735AL	24798	Lint Stripper Set Screw for 164462
853AL	24800	Looper (left hand) Thread Tube Set Screw for 164179 and 164268
858AL	24764	Thread Unwinder Spool Rest Hub Set Screw for 151023
896AL	24755	Needle Driving Shaft Crank Connection Cap (lower) Screw for 164116 (2)
896AL	24761	Thread (looper) Plate Screw (2)
904E	24799	Looper (right hand) Position Collar Set Screw for 164219
914J	24767	Cloth Plate Extension Screw for 164108 (2)
914C	24799	Looper (right hand) Carrier Connection Guide Bar Bracket Screw (left)
914C	24756	Machine Frame Bottom Cover Screw (13)
914J	24756	Machine Frame Cover (back) Screw (short)
1019AL	24799	Looper (right hand) Carrier Connection Hinge Stud Adjusting Pin Set Screw for 164061
1036AL	24759	Machine Frame Oil Plug Bracket Set Screw
1036AL	24755	Machine Frame Rotary Shaft Bushing (front) Set Screw
1036AL	24755	Machine Frame Rotary Shaft Counterbalance Set Screw for 164096
1057AL	24799	Looper (right hand) Carrier Connection Guide Bar Bracket Screw (right)
1083C	24799	Looper (left hand) Driving Shaft Crank Clamping Screw for 164051

No.	Plate	Name
1083C	24799	Looper (right hand) Driving Lever Clamping Screw for 164062
1083C	24799	Looper (right hand) Driving Shaft Crank Clamping Screw for 164066
1083C	24770	Needle Driving Shaft Crank Clamping Screw for 164114
1094F	24800	Throat Plate Screw (2)
1100AL	24804	Feed Dog Section (right) Screw for 164281
1122C	24764	Thread Unwinder Spool Rest Rod Set Screw for 151025 (2)
1143AL	24798	Knife (movable) Lever Hinge Stud Set Screw (top)
1209J	24767	Chip Guard Screw (lower)
1250AL	24767	Cloth Plate Lock Spring Screw Stud
1324C	24799	Looper (left hand) Carrier Screw for 164212
1324C	24799	Looper (left hand) Driving Shaft Crank Key Screw
1324C	24799	Looper (right hand) Driving Shaft Crank Key Screw
1324J	24759	Oil Cooler Screw (short)
1389C	24797	Feed Bar Hinge Pin Set Screw
1423J	24805	Guide (swing-out) Arm Lock Spring Screw for 164311
1423J	24761	Thread (looper, right hand) Thread Eyelet Screw for 164174
1425J	24805	Guide (swing-out) Hinge Screw for 164311
1443J	24805	Guide (swing-out) Screw for 164311 (2)
1443J	24799	Looper (right hand) Carrier Connection Hinge Stud Cap Screw for 164464
1443J	24761	Thread (looper, right hand) Stripper and Take-up Eyelet (adjustable) Screw for 164174
1443J	24799	Thread (looper) Take-up Screw (upper)
1443J	24798	Thread (needle) Controller Screw
1454F	24800	Feed Dog Screw
1454E	24798	Knife (stationary) Holder Adjusting Stud Cap Screw
1454E	24800	Throat Plate Guide Screw
1485J	24759	Oil Sight Gauge Window Retainer Screw (2)
1550J	24805	Guide (swing-out) Arm Lock Spring Screw Nut for 164311
1607J	24761	Thread (looper, right hand) Thread Eyelet (stationary) Nut for 164174
1628C	24797	Feed Bar Slide Block (back) Nut
1637K	24756	Presser Bar Lifting Lever Stop Screw Nut for 164080
1671C	24797	Feed Bar Connection Hinge Screw Stud Nut for 164276
1698J	24759	Machine Frame Oil Lead Screw Nut
1700J	24767	Cloth Plate Extension Screw Nut for 164108
1700J	24767	Cloth Plate Lock Spring Nut for 164108
1700J	24799	Looper (right hand) Locking Screw Stud Nut for 164464
1700J	24798	Presser Bar (swing-out) Lifting Screw Stud Nut for 164317
2102	24772	Tension (light) Disc for 164160 (2)
2102	24772	Tension (heavy) Disc for 164162 (4)
4879	24763	Foot Lifter Chain Connecting Link for 4885
4881	24763	Foot Lifter Treadle for 4885
4882	24763	Foot Lifter Treadle Shaft for 4885
4883	24763	Foot Lifter Treadle Spring for 4885
4884	24763	Foot Lifter Treadle Stand for 4885
4885	24763	Foot Lifter Treadle complete, Nos. 4879, 4881, 4882, 4883, 4884 and two wood screws 1 in. No. 16 F.H.
6439	24763	Foot Lifter Chain 36 in. to 45 in. with 56864 and 56865
10875	24797	Wrench (flat) for 1701 and 51649 (accessories)
17022	24797	Feed Bar Slide Block (back) Nut Washer
17022	24799	Thread (looper, right hand) Stripper and Take-up Screw Washer
26026	24801	Screw Driver (Accessories)
39541	24798	Knife (stationary) Holder Adjusting Stud Cap Screw Washer
42436	24805	Guide (swing-out) Hinge Screw Washer for 164311
45057	24799	Looper (left hand) Driving Shaft Crank Key Screw Washer
45057	24799	Looper (right hand) Driving Shaft Crank Key Screw Washer

NOTE: When ordering No. 6439, give length required

No.	Plate	Name
50060K	24770	Presser Bar (swing-out) Opening Lever Hinge Screw for 164247
50073J	24770	Knife (movable) Lever Cover and Presser Bar (upright) Housing Screw (2)
50133C	24772	Tension (heavy) Screw Stud for 164156 (2)
50133C	24772	Tension (light) Screw Stud for 164156
50169J	24800	Presser Foot Guide Screw for 164150
50225J	24800	Presser Foot Clamping Plate Screw for 164150, 164284, 164474 and 164475
50267R	24805	Guide (swing-out) Arm Holder Screw for 164494 (2)
50311C	24764	Thread Unwinder Thread Guide (lower) Holder Set Screw for 151027
50318W	24761	Thread (looper) Plate Thread Bushing Screw for 164174
50370E	24799	Looper (right hand) Carrier Hinge Pin Set Screw for 164056
50379F	24799	Looper (left hand) Set Screw for 164046
50421AL	24798	Knife (movable) Lever Bearing Set Screw (long)
50421AL	24798	Knife (movable) Lever Guide Holder Thread Tube Set Screw
50421AL	24798	Knife (movable) Lever Hinge Stud Set Screw (back)
50421AL	24759	Machine Frame Oil Tube Set Screw
50571J	24756	Machine Frame Cover (back) Screw (long) (2)
50608R	24763	Machine Base Plug Screw for 164184
51023W	24770	Machine Frame Oil Splash Guard (top) Screw (2)
51139J	24759	Oil Cooler Screw (long) (2)
51229J	24805	Presser Foot Guide Screw for 164474 and 164475
51306E	24800	Presser Foot Chain Cutter Knife Screw for 164150
51326J	24763	Belt Guard Screw for 164201 (2)
51332C	24755	Machine Frame Rotary Shaft Bushing (intermediate) Set Screw
51362AL	24798	Presser Bar (swing-out) Pivot Screw Lock Washer Screw
51369C	24755	Machine Frame Rotary Shaft Ball Bearing Housing Screw (3)
51369J	24772	Machine Frame Top Cover Screw (3)
51630	24759	Oil Cooler Oil Tube Lock Nut
51649C	24755	Machine Frame Rotary Shaft Nut
51720C	24770	Needle Clamping Nut for 164275
51846	24770	Presser Bar Lifting Bracket Roller and Stud for 164137
56864	24763	Foot Lifter Chain Hook (large) for 6439
56865	24763	Foot Lifter Chain Hook (small) for 6439
59456	24798	Knife (stationary) Holder Sleeve Screw Washer
59456	24799	Looper (left hand) Carrier Screw Washer for 164212
59537	24772	Tension (heavy) Spring Bushing for 164162 (2)
59537	24772	Tension (light) Spring Bushing for 164160
131056	24755	Machine Frame Rotary Shaft Nut Washer
132565	24799	Looper (right hand) Carrier Hinge Pin for 164464
132583	24798	Knife (movable) Lever Hinge Pin with 132584, for 164211
132584	24798	Knife (movable) Lever Hinge Pin Oil Wick for 132583
138269	24759	Oil Cooler Oil Tube Sleeve for 164126
139017	24763	Machine Base Plug Screw Washer for 164184
139026	24755	Machine Frame Rotary Shaft Ball Bearing
140050C	24798	Knife (movable) Clamp Screw
140088R	24798	Knife (stationary) Holder Sleeve Screw
140088R	24759	Machine Frame Oil Lead Screw
140159AL	24755	Looper (left hand) Driving Shaft Crank Connection Cap (upper) Screw for 164052 (2)
140159AL	24755	Looper (right hand) Driving Shaft Crank Connection Cap (upper) Screw for 164052 (2)
140180J	24804	Presser Foot Screw for 164387
140180J	24805	Presser Foot Thread Chain Guard Screw for 164494
140200J	24756	Machine Frame Cover (back) Slide Position Screw for 164080
140228C	24756	Presser Bar Lifting Lever Stop Screw for 164080

Library of: Diana Keck Airy

No.	Plate	Name
140239AL	24798	Knife (movable) Lever Guide Holder Set Screw for 164181 (2)
140239AL	24798	Thread Eyelet (needle thread) Set Screw
140393AL	24799	Looper (left hand) Carrier Holder Set Screw (right) for 164047
140394E	24799	Looper (left hand) Driving Shaft Bushing (back) Cap Screw
140394E	24799	Looper (right hand) Driving Shaft Bushing (back) Cap Screw
140395C	24759	Machine Frame Bracket Screw (small) for 164526 (3)
140396E	24759	Machine Frame Bracket Screw (large) for 164526
140416X	24755	Machine Pulley Cap Screw
140418E	24755	Machine Screw Stud (back)
140509J	24767	Chip Guard Screw (upper)
140510C	24798	Presser Bar (swing-out) Pivot Screw
140596AL	.....	Looper (left hand) Carrier Holder Set Screw (left) for 164047
140596AL	24799	Looper (right hand) Driving Lever Set Screw for 164062 (2)
140596AL	24770	Needle Driving Shaft Crank Set Screw for 164114 (2)
150203	24764	Thread Unwinder Spool Rest Cushion (felt) for 151031 and 151163
151023	24764	Thread Unwinder Spool Rest with 858AL and three each 201528, 228692 and 395243, for 151031 and 151163
151024	24764	Thread Unwinder Spool Rest Rod for 151031 and 151163
151025	24764	Thread Unwinder Spool Rest Stand with two 1122C and three wood screws 1 in. No. 12 F.H., for 151031 and 151163
151026	24764	Thread Unwinder Thread Guide (lower) for 151031 and 151163
151027	24764	Thread Unwinder Thread Guide (lower) Support with 50311C, for 151031 and 151163
151028	24764	Thread Unwinder Thread Guide (upper, hollow) for 151031 and 151163 (2)
151029	24764	Thread Unwinder Thread Guide (upper) Holder with four 453AL, for 151031 and 151163
151030	24764	Thread Unwinder Thread Guide Rod for 151031 and 151163
151031	24764	Thread Unwinder complete for three spools, Nos. 151023, 151024, 151025, 151026, 151027, 151029, 151030, two 151028 and three 150203
151162	24806	Thread Unwinder Thread Guide (upper, solid) for 151163
151163	24806	Thread Unwinder complete for four spools, Nos. 151023, 151024, 151025, 151026, 151027, 151029, 151030, 151162, 225259, two 151028 and four 150203
160725	24801	Oil Container for 160727 (Accessories)
160726	24801	Oil Container Cap for 160727 (Accessories)
160727	24801	Oil Container (filled, 5 oz. Mfg. Oil, light grade, not stainless) Nos. 160725 and 160726 (Accessories)
160728	24801	Oil Container Spout for 160727, for use when filling Oil Reservoir (Accessories)
164001	24767	Chip Guard
164002	24767	Cloth Plate Extension for 164108
164003	24797	Feed Bar Hinge Pin (eccentric)
164004	24797	Feed Bar Slide Block (cab) for 164276
164005	24797	Feed Bar Slide Block (front) for 164276
164006	24797	Feed Bar with 164010, for 164276
164008	24797	Feed Bar Connection Bearing for 164276
164009	24797	Feed Bar Connection Hinge Screw Stud for 164276
164010	24797	Feed Bar Connection Hinge Screw Stud Nut Position Pin for 164006
164017	24797	Feed Bar Connection for 164276
164020	24797	Feed Eccentric

NOTE: Feed Eccentric No. 164020 is furnished in 4 to 16, 18, 20, 22, 24, 28, 32 and 36 stitches to the inch, unless otherwise stated. No. 164020 (5 stitches to the inch) is supplied regularly.

No.	Plate	Name
164025	24755	Feed Lifting and Knife (movable) Eccentric
164026	24798	Knife (movable) for 164319
164029	24798	Knife (movable) Holder
164030	24798	Knife (movable) Holder Screw Bearing
164031	24798	Knife (movable) Lever with 620AL, for 164211
164032	24798	Knife (movable) Lever Bearing
164034	24798	Knife (movable) Lever Hinge Stud for 164035
164035	.....	Knife (movable) Lever Hinge Stud 164034 with 164036 and 164269, for 164211
164036	24798	Knife (movable) Lever Hinge Stud Oil Wick (long) for 164035
164040	24798	Knife (stationary) Holder Adjusting Stud
164042	24798	Knife (stationary) Holder Sleeve
164043	24798	Knife (stationary) Holder Spring
164045	24799	Looper (left hand)
164046	24799	Looper (left hand) Carrier with 460AL, 50379F and 164202, for 164212
164047	24799	Looper (left hand) Carrier Holder with 140393AL and 140596AL, for 164212
164048	24799	Looper (left hand) Driving Shaft
164049	24799	Looper (left hand) Driving Shaft Bushing (back)
164049	24799	Looper (right hand) Driving Shaft Bushing (back)
164050	24799	Looper (left hand) Driving Shaft Bushing (front)
164051	.....	Looper (left hand) Driving Shaft Crank with 1083C, for 164215
164052	24755	Looper (left hand) Driving Shaft Crank Connection with two each 171AL and 140159AL, for 164215
164052	24755	Looper (right hand) Driving Shaft Crank Connection with two each 171AL and 140159AL, for 164216
164053	24799	Looper (left hand) Driving Shaft Crank Thrust Bearing
164053	24799	Looper (right hand) Driving Shaft Crank Thrust Bearing
164054	24800	Looper (left hand) Thread Tube
164055	24799	Looper (right hand) for 164319
164056	24799	Looper (right hand) Carrier with 50370E, for 164464
164057	24799	Looper (right hand) Carrier Connection for 164464
164058	24799	Looper (right hand) Carrier Connection Guide Bar with 624AL and 168215, for 164464
164060	24799	Looper (right hand) Carrier Connection Guide Bar Bracket Oil Pad for 164463
164061	24799	Looper (right hand) Carrier Connection Hinge Stud with 1019AL, for 164464
164062	24799	Looper (right hand) Driving Lever with 1083C and two 140596AL, for 164464
164063	24799	Looper (right hand) Driving Shaft
164065	24799	Looper (right hand) Driving Shaft Bushing (front)
164066	24799	Looper (right hand) Driving Shaft Crank with 1083C, for 164216
164067	24799	Looper (left hand) Driving Shaft Crank Key
164067	24799	Looper (right hand) Driving Shaft Crank Key
164068	24799	Looper (right hand) Locking Screw Stud for 164464
164071	24755	Machine Pulley Cap
*164072	.....	Machine Frame for 164526
164074	24756	Machine Frame Bottom Cover
164075	24756	Machine Frame Bottom Cover Gasket
164077	24759	Machine Frame Bracket Screw (large) Washer (fiber) for 164526
164078	24756	Machine Frame Cover (back) for 164080
164079	24756	Machine Frame Cover (back) Slide for 164080
164080	24756	Machine Frame Cover (back) complete, Nos. 238J, 1637K, 140200J, 140228C, 164078 and 164079
164081	24759	Machine Frame Oil Lead
164082	24759	Machine Frame Oil Plug Bracket



No.	Plate	Name
164083	24759	Machine Frame Oil Screen
164084	24759	Machine Frame Oil Splash Guard (internal)
164085	24770	Machine Frame Oil Splash Guard (top)
164086	24759	Machine Frame Oil Tube with 164087
164087	24759	Machine Frame Oil Tube Wick for 164086
164088	24755	Machine Frame Plug
164089	24755	Machine Frame Rotary Shaft for 164090
164090		Machine Frame Rotary Shaft 164089 with 164097, 164215, 164216, 164217 and two each 164093 and 164232
164091	24799	Thread (looper, right hand) Stripper and Take-up for 164319
164092	24755	Machine Frame Rotary Shaft Ball Bearing Housing
164093	24755	Machine Frame Rotary Shaft Ball Sleeve (two pieces) for 164090 (2)
164094	24755	Machine Frame Rotary Shaft Bushing (front)
164095	24755	Machine Frame Rotary Shaft Bushing (intermediate)
164096	24755	Machine Frame Rotary Shaft Counterbalance with 1036AL
164097	24755	Machine Frame Rotary Shaft Key for 164090
164098	24755	Machine Frame Rotary Shaft Oil Sling and Ball Bearing Grease Retainer
164099	24755	Machine Frame Rotary Shaft Screw Stud
164100	24755	Machine Frame Rotary Shaft Thrust Bearing
164101	24772	Machine Frame Top Cover for 164214
164102	24772	Machine Frame Top Cover Gasket
164103	24772	Machine Frame Top Cover Oil Lead for 164214
164104	24767	Cloth Plate Plunger
164105	24767	Cloth Plate Plunger Spring
164106	24767	Cloth Plate Position Collar with two 624AL
164107	24767	Cloth Plate for 164108
164108	24767	Cloth Plate with Extension complete, Nos. 164002, 164107, 164205 and two each 914J and 1700J
164109	24770	Needle Clamp for 164275
164110	24770	Needle Driving Shaft with 164118, for 164275
164111	24770	Needle Driving Shaft Bushing
164112	24770	Needle Driving Shaft Bushing Cap
164113	24770	Needle Driving Shaft Bushing Oil Lead
164114	24770	Needle Driving Shaft Crank with 1083C and two 140596AL
164115	24770	Needle Driving Shaft Crank Ball for 164217
164116	24755	Needle Driving Shaft Crank Connection with two each 171AL and 896AL, for 164217
164117	24770	Needle Holder for 164275
164118	24770	Needle Stop Pin for 164110
164119	24755	Oil Agitator
164120	24759	Oil Cooler with two 164125
164121	24759	Oil Cooler Cover for 164123
164122	24759	Oil Cooler Cover Gasket
164123	24759	Oil Cooler Cover 164121 with 164135
164124	24759	Oil Cooler Gasket
164125	24759	Oil Cooler Oil Pipe (outlet) for 164120 (2)
164126	24759	Oil Cooler Oil Tube with 138269 and 164128
164127	24759	Oil Cooler Oil Tube Coupling
164128	24759	Oil Cooler Oil Tube Wick for 164126
164131	24759	Oil Sight Gauge Background Disc
164132	24759	Oil Sight Gauge Background Disc Gasket
164132	24759	Oil Sight Gauge Window Gasket
164132	24759	Oil Sight Gauge Window Retainer Gasket
164133	24759	Oil Sight Gauge Window
164134	24759	Oil Sight Gauge Window Retainer
164135	24759	Oil Cup for filling machine for 164123
164136	24798	Presser Bar Bracket for 164211
164137	24770	Presser Bar Lifting Bracket with 462AL, 624AL and 51846, for 164247

No.	Plate	Name
164138	24770	Presser Bar Lifting Lever for 164247
164139	24770	Presser Bar Lifting Lever Spring for 164247
164141	24798	Presser Bar (swing-out) Lifting Screw Stud, for 164317
164142	24770	Presser Bar (swing-out) Opening Lever for 164247
164143	24770	Presser Bar (upright) for 164247
164144	24770	Presser Bar (upright) Spring for 164247
164145	24800	Presser Foot Body for 164150
164146	24800	Presser Foot Chaining-off Finger for 164150 and 164475
164147	24800	Presser Foot Clamping Plate for 164150, 164474 and 164475
164149	24800	Presser Foot Guide for 164150
164150	24800	Presser Foot with Chain Cutter complete for 164317, Nos. 50169J, 50225J, 51306E, 164145, 164146, 164147, 164149, 164220 and 164221
164151	24798	Thread (needle) Controller for 164319
164153	24798	Thread (needle) Controller Lever for 164211
164155	24772	Tension (heavy) Regulating Thumb Nut for 164156 (2)
164155	24772	Tension (light) Regulating Thumb Nut for 164156
164156		Tension (heavy) Screw Stud 50133C with 164155, for 164162 (2)
164156		Tension (light) Screw Stud 50133C with 164155, for 164160
164157	24772	Tension (light) Spring for 164160
164158	24772	Tension (heavy) Spring Cover for 164162 (2)
164158	24772	Tension (light) Spring Cover for 164160
164159	24772	Tension (needle thread) Thread Guide
164160	24772	Tension (light) complete, Nos. 59537, 164156, 164157, 164158 and two 2102
164161	24772	Tension (heavy) Spring for 164162 (2)
164162	24772	Tension (heavy) complete, Nos. 59537, 164156, 164158, 164161 and two 2102 (2)
164163	24761	Thread (looper, right hand) Stripper and Take-up Eyelet (adjustable) for 164174
164164	24761	Thread (looper, right hand) Thread Eyelet (movable) for 164174
164165	24761	Thread (looper, right hand) Thread Eyelet (stationary) for 164174
164166	24761	Thread (looper, right hand) Tube for 164174
164167	24761	Thread (looper) Plate with 624AL, for 164174
164168	24761	Thread (looper) Plate Cover for 164206
164169	24761	Thread (looper) Plate Cover Hinge for 164206
164170	24761	Thread (looper) Plate Cover Hinge Pin for 164206
164171	24761	Thread (looper) Plate Cover Spring for 164174 (2)
164173	24761	Thread (looper) Plate Thread Bushing for 164174
164174		Thread (looper) Plate complete, Nos. 1423J, 1443J, 1607J, 50318W, 164163, 164164, 164165, 164166, 164167, 164173, 164206 and two each 332J and 164171
164175	24799	Thread (looper) Take-up (left) for 164319
164176	24799	Thread (looper) Take-up Plate
164177	24798	Thread Eyelet (needle thread) for 164210
164179	24800	Throat Plate Guide with 853AL, for 164319
164180	24798	Knife (movable) Lever Guide for 164210
164181	24798	Knife (movable) Lever Guide Holder with two 140239AL, for 164210
164182	24798	Knife (movable) Lever Guide Holder Thread Tube for 164210
164183	24763	Belt Guard for 164201
164184	24763	Machine Base with 50608R, 139017 and two each wood screws 3/4 in. No. 8 R.H. and 1 1/4 in. No. 6 F.H.
164188	24763	Machine Cushion (large) (2)
164189	24763	Machine Cushion (small) (2)
164190	24763	Machine Pad (felt)
164194	24770	Pressure Regulating Thumb Screw for 164247

No.	Plate	Name
164196	24801	Threader (Accessories) (6)
164197	24801	Wrench (socket) Accessories
164198	24801	Presser Bar Lifting Chain Spring (under table) (Accessories)
164199	24763	Belt Guard Bracket (back) for 164201
164200	24763	Belt Guard Bracket (front) for 164201
164201	24763	Belt Guard (adjustable) complete, Nos. 164183, 164199, 164200 and two each 51326J and wood screws 3/4 in. No. 7 F.H.
164202	24799	Looper (left hand) Stop Pin for 164046
164203	24801	Feed Eccentric Extractor (not regularly furnished with Machine)
164204	24801	Tweezers (Accessories)
164205	24767	Cloth Plate Lock Spring for 164108
164206		Thread (looper) Plate Cover 164168 with 164169 and 164170, for 164174
164207	24759	Machine Frame Bracket Key for 164528
164210	24798	Knife (movable) Lever Guide Holder 164181 with 197J, 164177, 164180 and 164182
164211		Knife (movable) Lever 164031 with 132583, 164035, 164136 and 164153
164212		Looper (left hand) Carrier Holder 164047 with 1324C, 59456 and 164046
164214		Machine Frame Top Cover 164101 with 330J, 164103 and two 164418
164215		Looper (left hand) Driving Shaft Crank 164051 with 164052, for 164090
164216		Looper (right hand) Driving Shaft Crank 164066 with 164052, for 164090
164217		Needle Driving Shaft Crank Connection 164116 with 164115, for 164090
164219	24799	Looper (right hand) Position Collar with 904E
164220	24800	Presser Foot Chain Cutter Friction Plate for 164150
164221	24800	Presser Foot Chain Cutter Knife for 164150
164228	24800	Throat Plate for 164319
164229	24759	Machine Frame Bracket Screw (large) Washer (felt)
164231	24755	Machine Pulley (round and "V" belt) with two 448AL
164232	24755	Machine Frame Rotary Shaft Ball Sleeve Guide for 164090 (2)
164233	24798	Knife (stationary)
164246	24770	Knife (movable) Lever Cover and Presser Bar (upright) Housing for 164247
164247		Knife (movable) Lever Cover and Presser Bar (upright) Housing complete, Nos. 50060K, 164137, 164138, 164139, 164142, 164143, 164144, 164194 and 164246
164252	24803	Spreader for 164346 and 164494
164258	24804	Presser Bar (swing-out) for 164387
164263	24804	Presser Foot Clamping Plate for 164284
164268	24804	Throat Plate Guide with 853AL, for 164387
164269		Knife (movable) Lever Hinge Stud Oil Wick (short) for 164035
164275		Needle Driving Shaft 164110 with 51720C, 164109 and 164117
164276		Feed Bar complete, Nos. 1671C, 164004, 164005, 164006, 164008, 164009 and 164017
164277	24797	Feed Bar Guide (roller)
164278	24797	Feed Bar Spacing Collar
164279	24804	Feed Dog Section (left) for 164281
164280	24804	Feed Dog Section (right) for 164281
164281	24804	Feed Dog complete for 164387, Nos. 1100AL, 164279, and 164280
164282	24804	Presser Foot Chaining-off Finger for 164284
164283	24804	Presser Foot Plate for 164284
164284	24804	Presser Foot complete for 164387, Nos. 50225J, 164263, 164282 and 164283

No.	Plate	Name
164285	24772	Tension (looper thread) Thread Guide (left)
164286	24772	Tension (looper thread) Thread Guide (right)
164290	24804	Throat Plate for 164387
164293	24799	Looper (left hand) Driving Shaft Bushing (back) Cap Screw Washer (fiber)
164293	24799	Looper (right hand) Driving Shaft Bushing (back) Cap Screw Washer (fiber)
164295	24803	Feed Dog, 18 teeth (12 teeth to the inch) for 164346
164297	24805	Guide (swing-out) Arm for 164311
164298	24805	Guide (swing-out) Arm Holder for 164311
164299	24805	Guide (swing-out) Extension (upper) for 164503
164303	24805	Presser Foot Guide for 164474 and 164475
164308	24803	Knife (movable) for 164346 and 164494
164311	24805	Guide (swing-out) with Arm and Holder complete for 164494, Nos. 1423J, 1425J, 1550J, 42436, 164297, 164298, 164503, 164541 and two 1443J
164317	24800	Presser Bar (swing-out) with Presser Foot complete, Nos. 1700J, 164141, 164150 and 164350
164318	24800	Feed Dog 21 teeth (16 teeth to the inch) for 164319
164319	24802	Set of Fittings complete for Sewing Pockets and Pillow Cases for three-thread stitch, Nos. 164026, 164055, 164091, 164151, 164175, 164179, 164228, 164317 and 164318
164345	24797	Feed Eccentric Oil Wick for 164400
164346	24803	Set of Fittings complete for Sewing Interlining and Lining together for two-thread stitch, Nos. 164252, 164295, 164308 and 164381
164350	24798	Presser Bar (swing-out) for 164317
164351	24798	Presser Bar (swing-out) Pivot Screw Lock Washer
164381	24803	Thread (needle) Controller for 164346, 164387 and 164494
164387	24804	Set of Fittings complete, for Dress Shields for Three-Thread Purl-on-edge Stitch, Nos. 140180J, 164258, 164268, 164281, 164284, 164290 and 164381
164397	24799	Looper (right hand) Carrier Connection Hinge Stud Adjusting Pin for 164464
164398	24797	Feed Eccentric Cover, for 164403
164400	24797	Feed Eccentric Cover Bracket with 164345, for 164403
164401	24797	Feed Eccentric Cover Latch Spring for 164403
164403	24797	Feed Eccentric Cover complete, Nos. 629K, 164398, 164400, 164401 and two 227J
164416		Presser Bar (upright) Spring (heavy)
164418	24772	Tension Thread Eyelet for 164214 (2)
164438	24805	Presser Foot Chaining-off Finger for 164474
164440	24805	Throat Plate for 164494
164459	24801	Gauge (Accessories) (not regularly furnished with Machine)
164461		Machine Frame Oil Tube Wick Retainer
164462	24798	Lint Stripper with 735AL
164463	24799	Looper (right hand) Carrier Connection Guide Bar Bracket with 164060 and two 462AL, for 164464
164464		Looper (right hand) Driving Lever 164062 with 1443J, 1700J, 132565, 164056, 164057, 164058, 164061, 164068, 164397 and 164463
164469	24805	Feed Dog for 164494
164471	24805	Presser Foot Body for 164474
164474	24805	Presser Foot complete for light and medium fabrics for 164494, Nos. 50225J, 51229J, 164147, 164303, 164438 and 164471
164475	24805	Presser Foot complete, for heavy-weight fabrics, for 164494, Nos. 50225J, 51229J, 164146, 164147, 164303 and 164471
164476	24805	Presser Foot Thread Chain Guard for 164494

From the Library of the International Sewing Machine Co.



164492	24805	Machine Frame Oil Splash Guard (top) for 164494
164494	24805	Set of Fittings complete, for Pants Serging for Light and Medium or Heavy-weight Fabrics for two-thread stitch, 1 4 in. bight, Nos. 140180J, 164252, 164308, 164311, 164381, 164440, 164469, 164474 or 164475, 164476, 164492 and two 50267R
164502	24805	Guide (swing-out) Extension (lower) for 164503
164503		Guide (swing-out) with Extension complete for 164311, Nos. 197J, 164299, 164502 and 164530
164507	24798	Knife (movable) Clamp and Guard
164522	24798	Knife (stationary) Clamping Stud
164523	24798	Knife (stationary) Clamping Stud Nut
164524	24798	Knife (stationary) Holder
164525	24798	Knife (stationary) Holder Spring Stud
*164526		Machine Frame complete, Nos. 140396E, 164072, 164077, 164528 and three 140395C
*164527		Machine Frame Bracket for 164528
*164528		Machine Frame Bracket 164527 with 164207 and two 187E, for 164526
164530	24805	Guide (swing-out) for 164503
164541	24805	Guide (swing-out) Arm Lock Spring for 164311
168198	24763	Chip Chute with four wood screws 3 8" No. 6 R.H. blacked
168215		Looper (right hand) Carrier Connection Guide Bar Oil Wick for 164058
201018C	24806	Thread Unwinder Spool Rest Set Screw for 225259
201528X		Thread Unwinder Spool Pin Nut for 151023 and 225259
225259	24806	Thread Unwinder Spool Rest with 201018C, 201528X, 228692 and 228693 (one spool) for 151163
228692	24806	Thread Unwinder Spool Pin for 151023 and 225259
228693		Thread Unwinder Spool Pin Washer for 225259
395243		Thread Unwinder Spool Pin Washer for 151023 (3)

SINGER Needles should be used in SINGER Machines. These Needles and their Containers are marked with the Company's Trade Mark "SIMANCO. \*\*" 1

Needles in Containers marked "FOR SINGER MACHINES" are NOT **SINGER** made needles. 2

24755 - 1/3

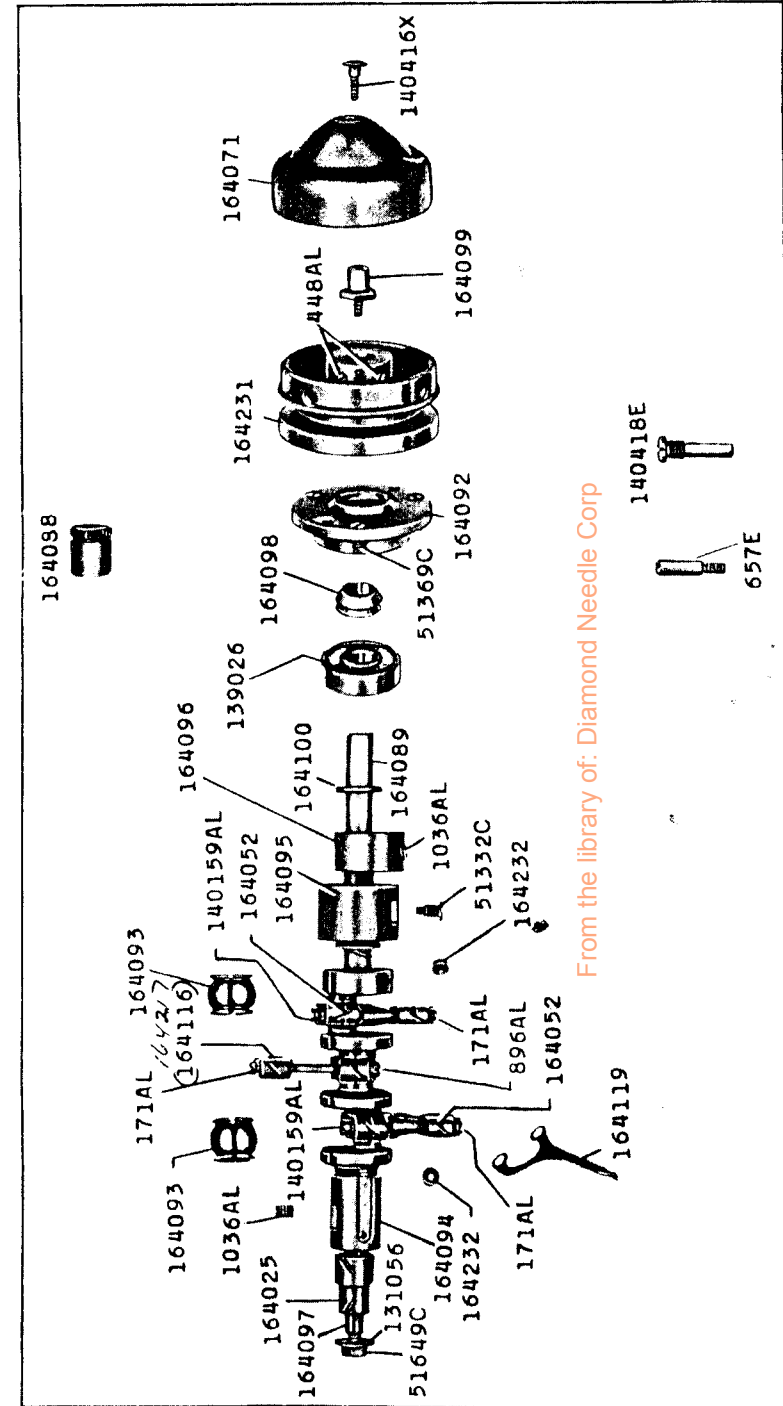

From the library of: Diamond Needle Corp

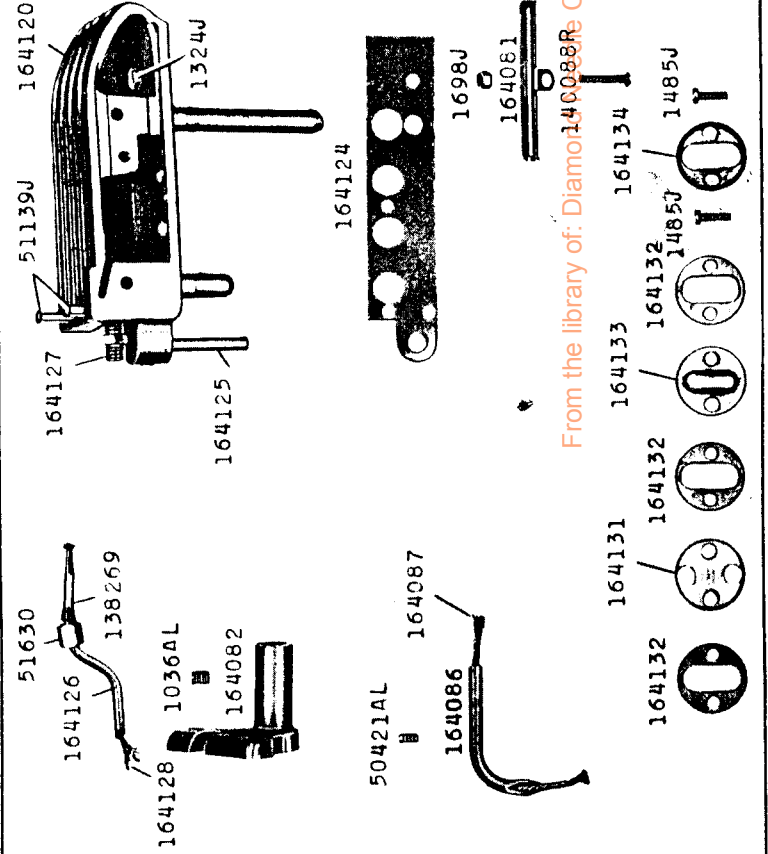
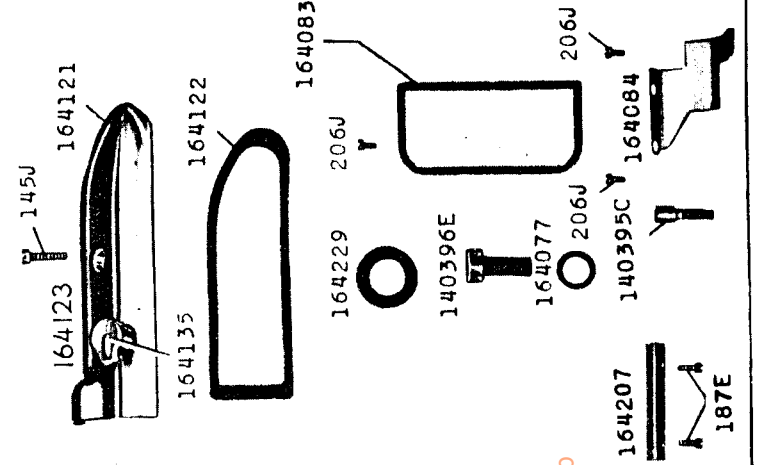
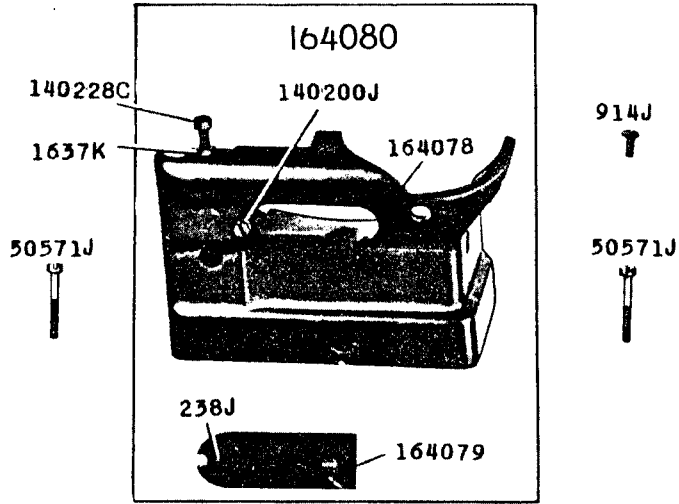
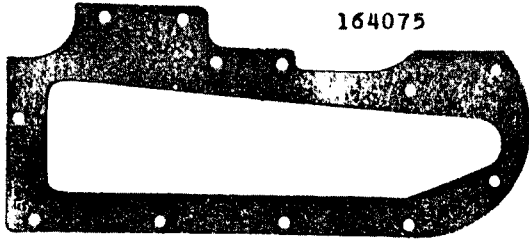
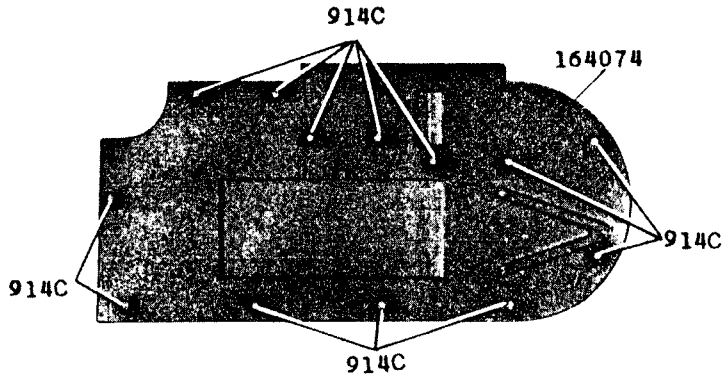

From the library of: Diamond & Morse Corp

24761 - 2/3

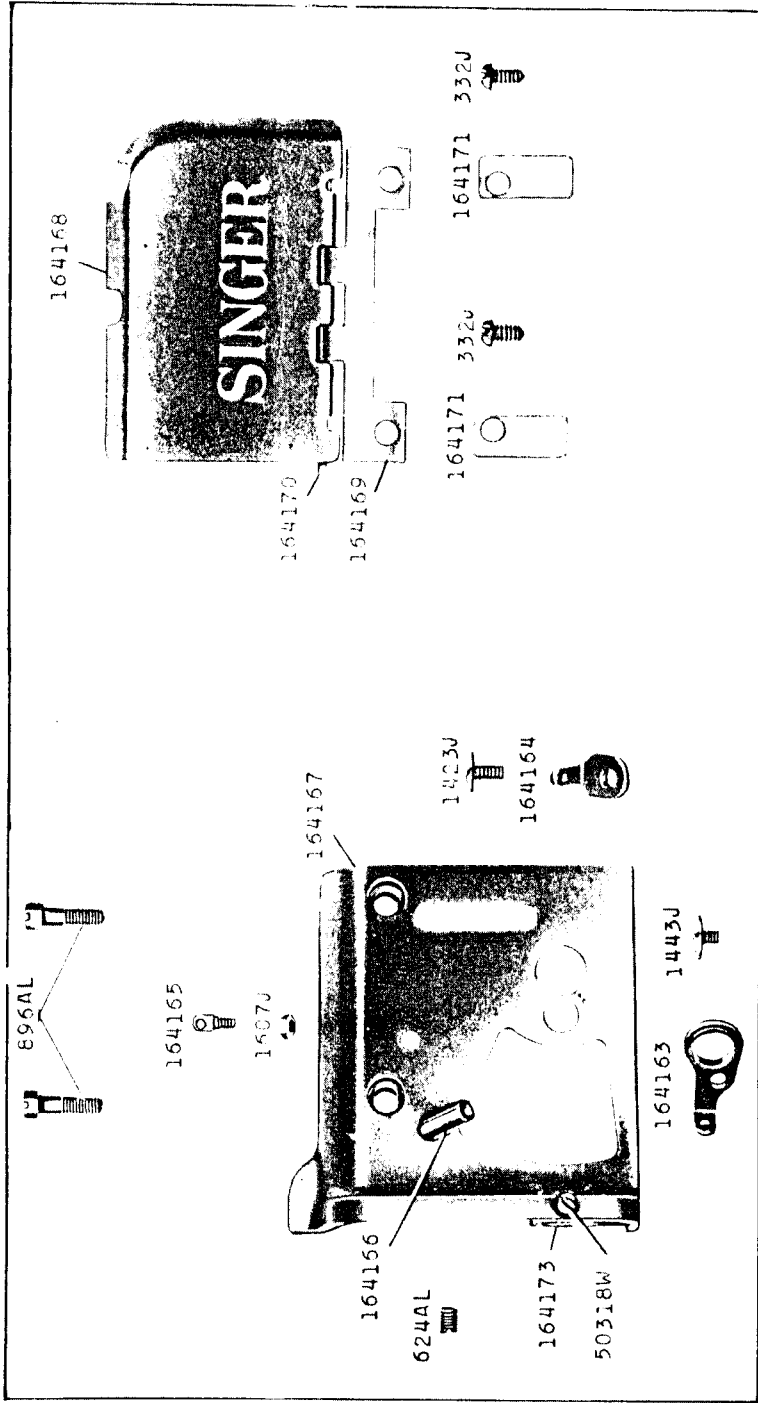

24763 - 1/4

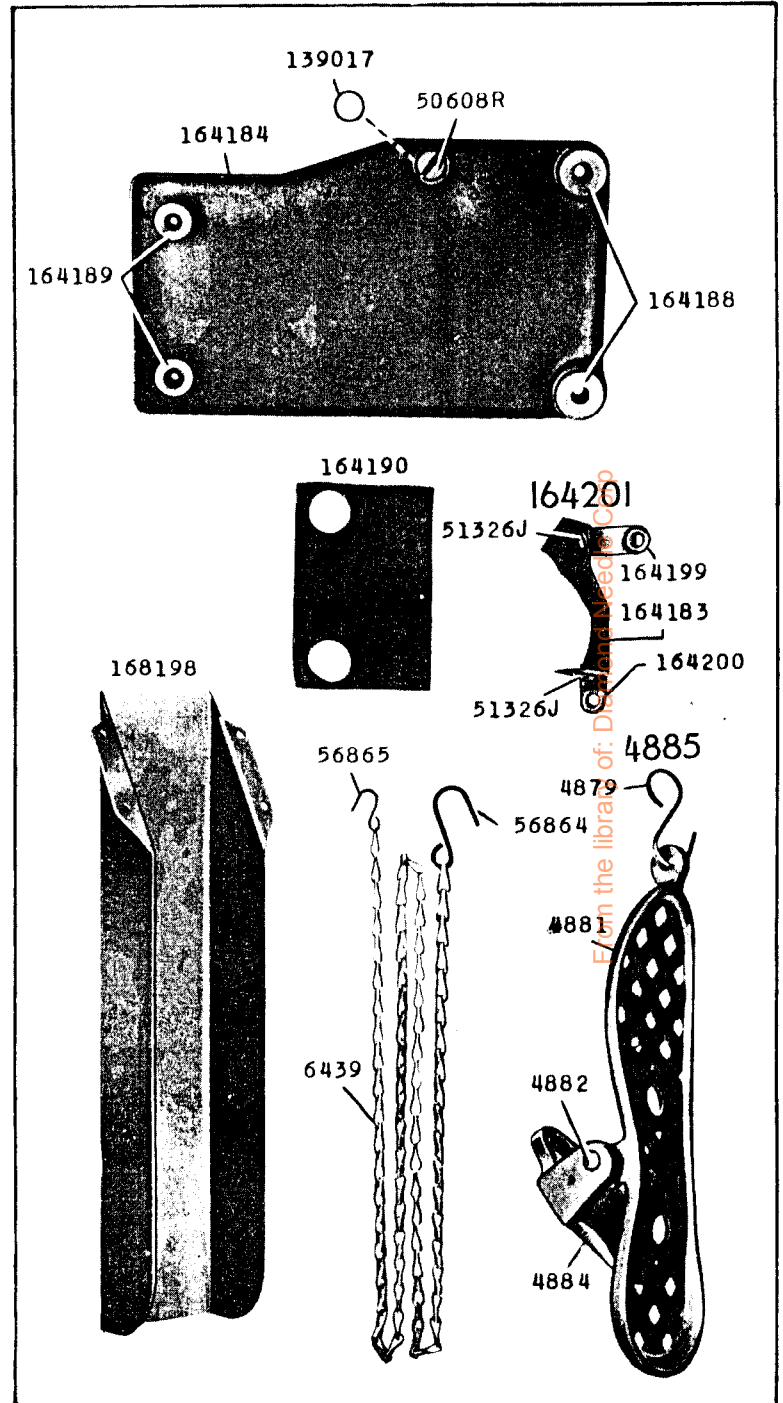

Printed vertically in red: Find the library of: Distant Needs Co.

24764 - 1/6

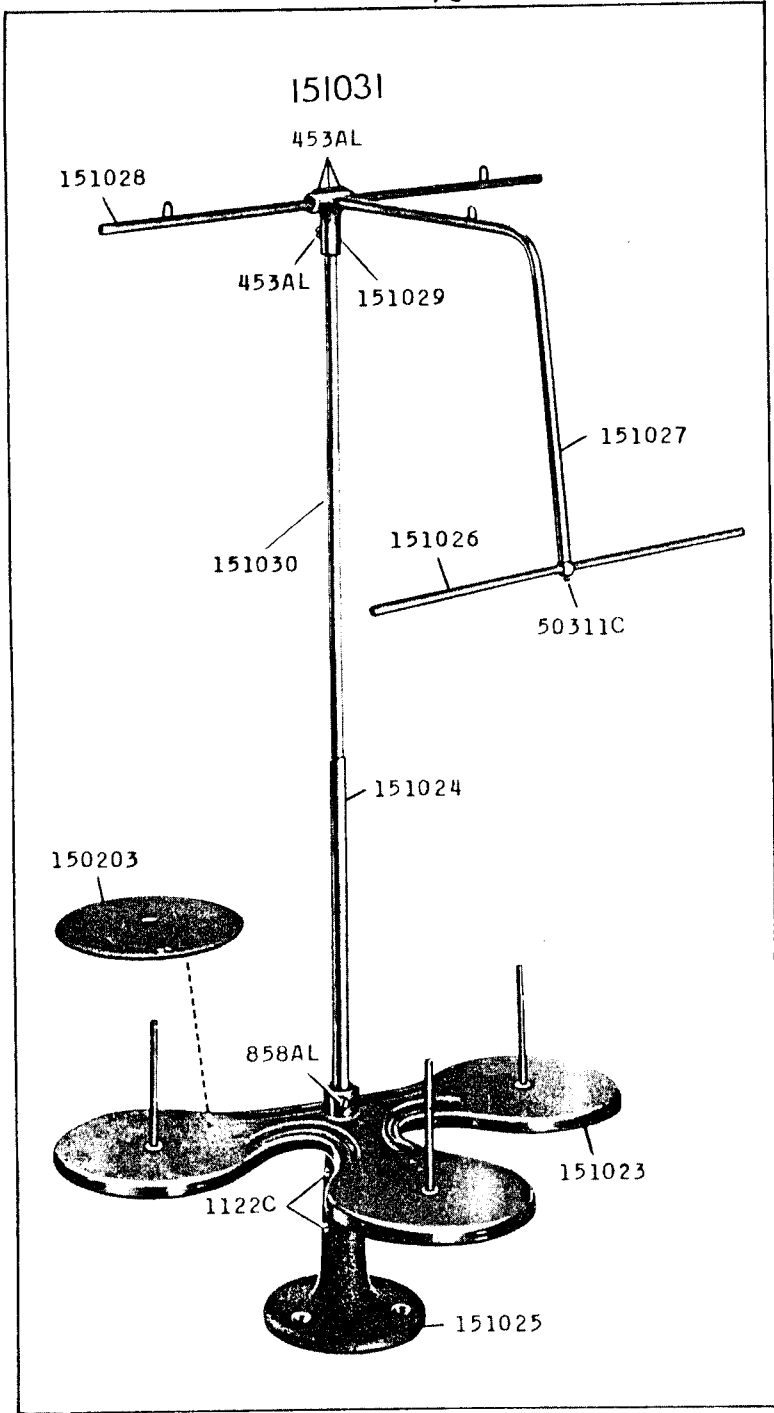

24767 - 1/2

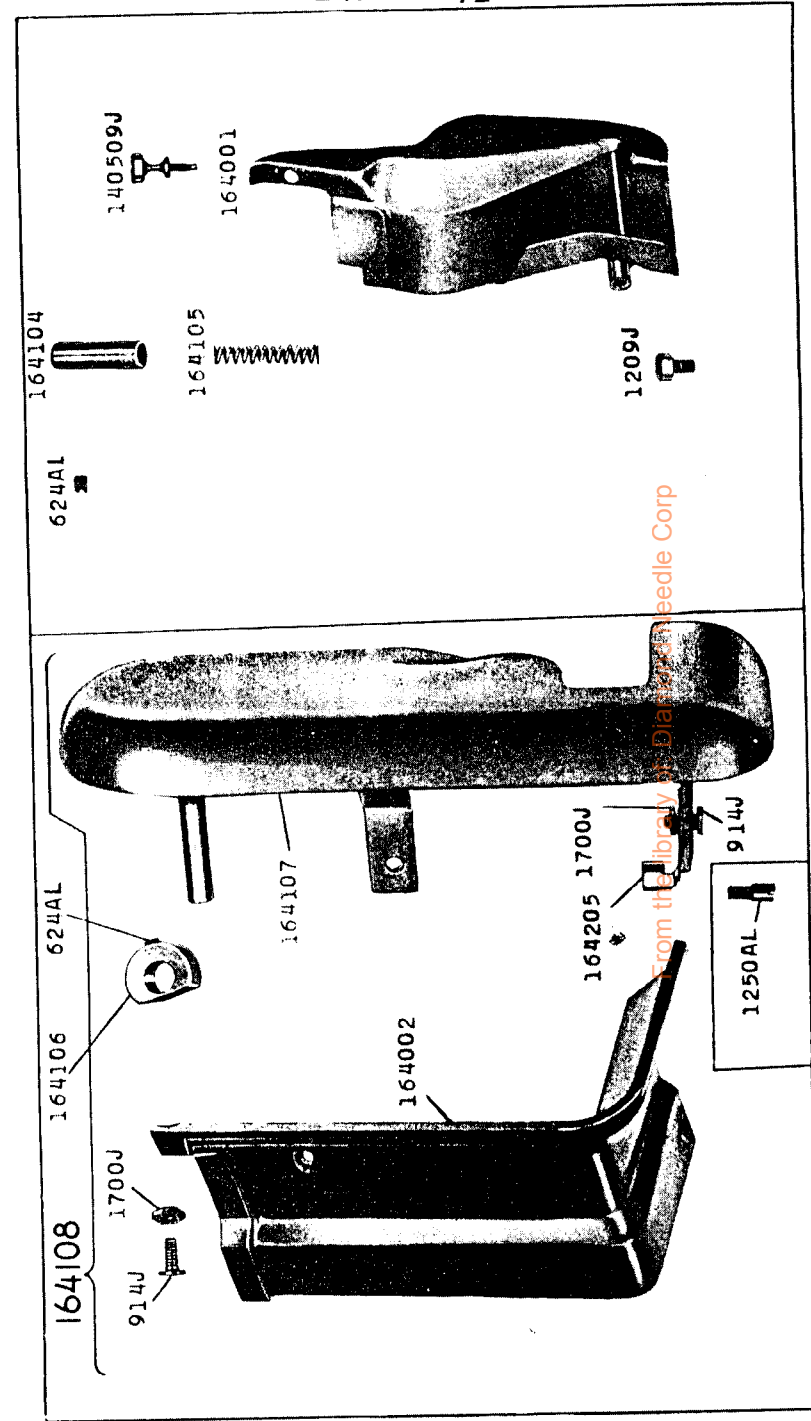

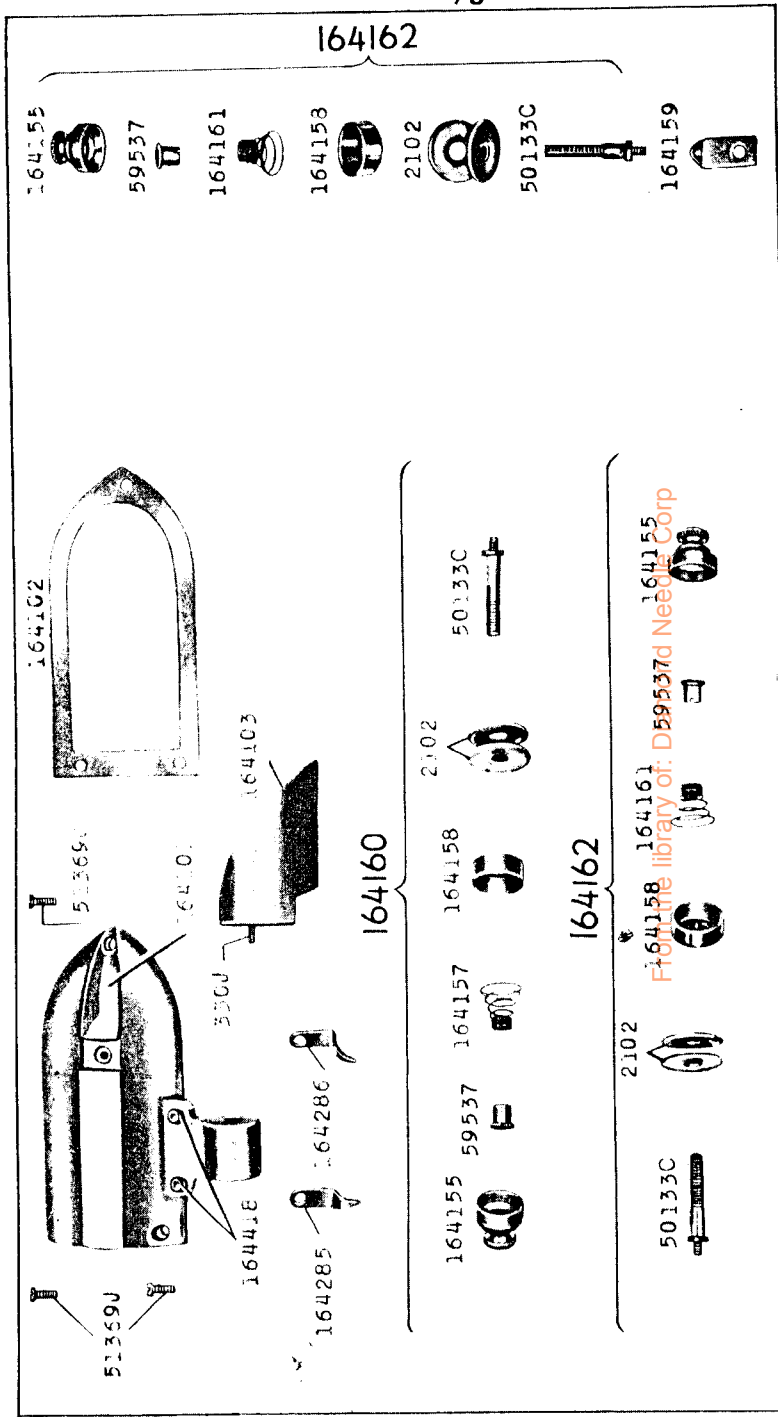
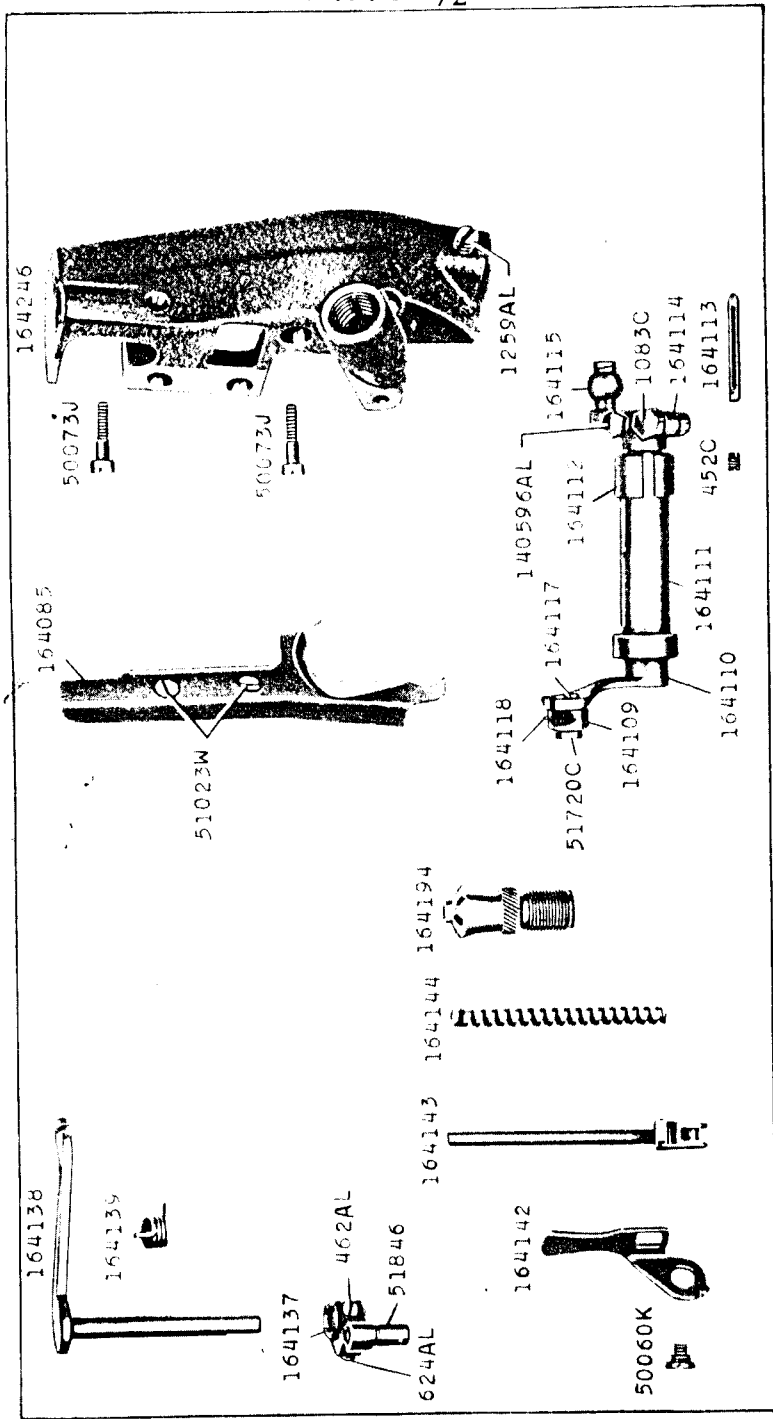

24797 - 2/3

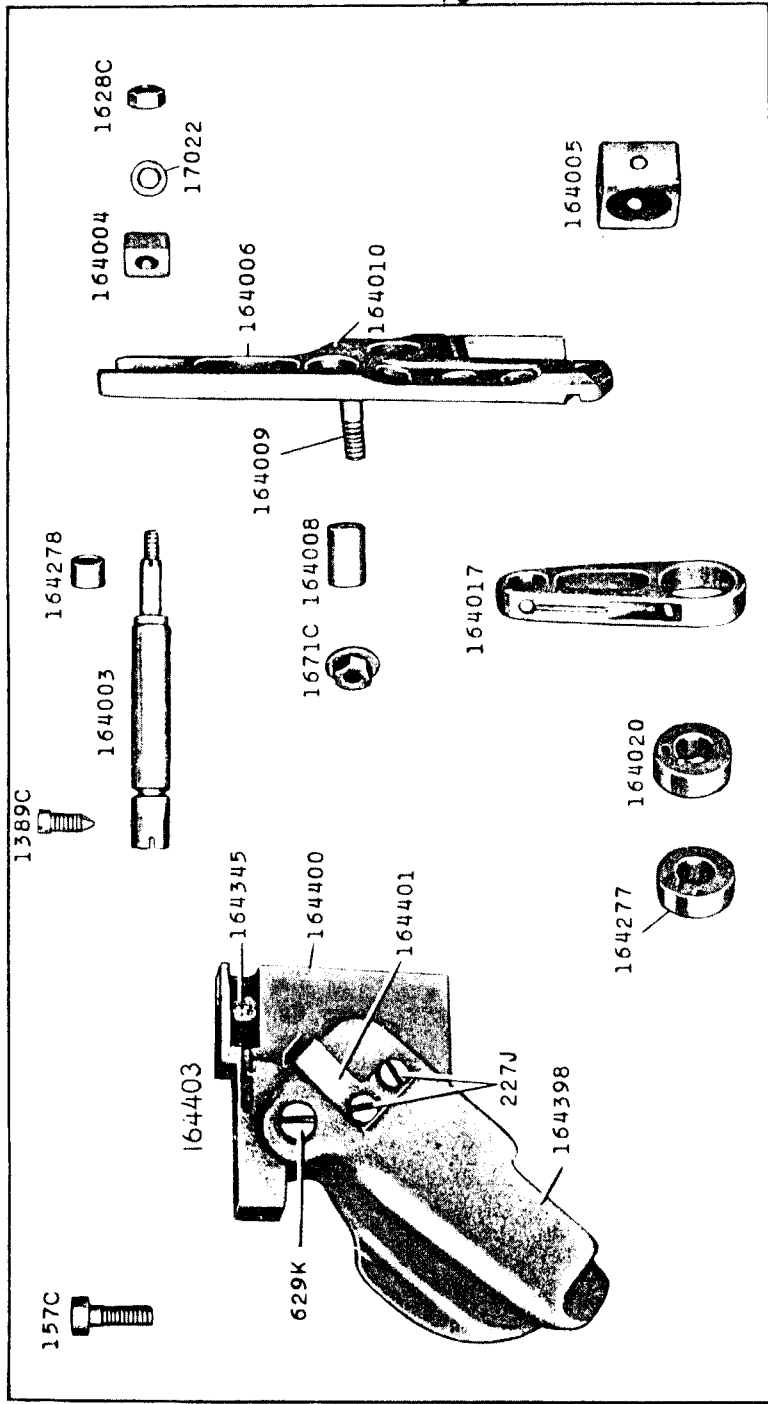

24798 - 1/2

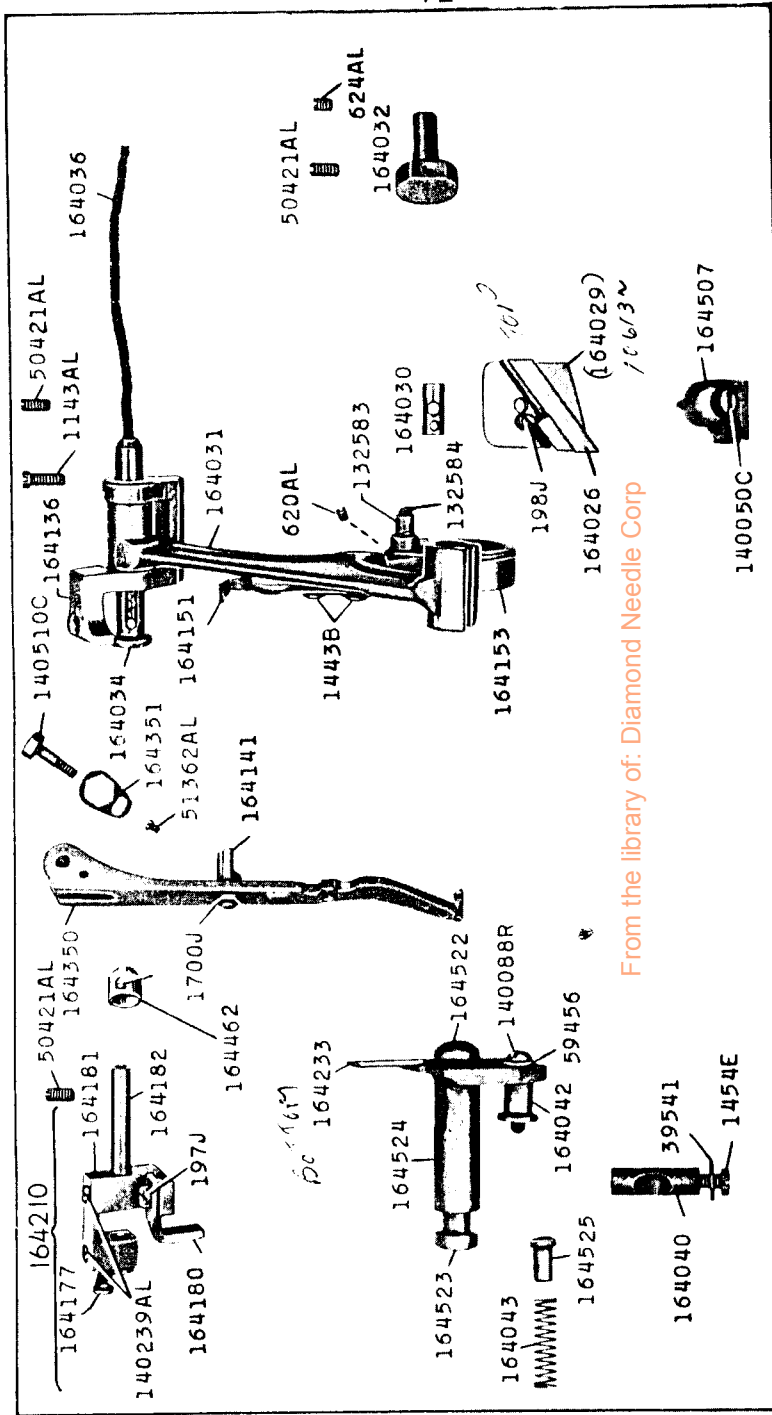

From the library of: Diamond Needle Corp



24799-1/2

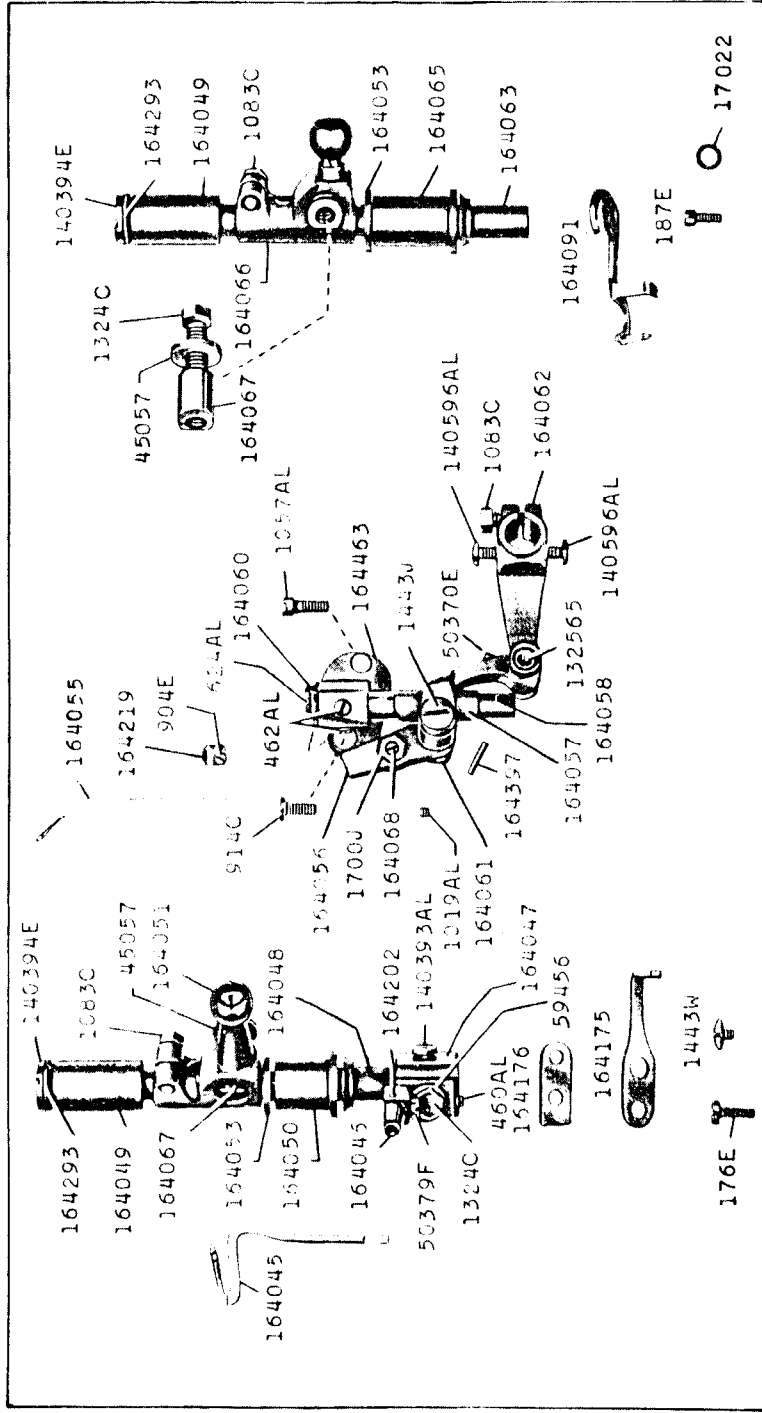

24800-2/3

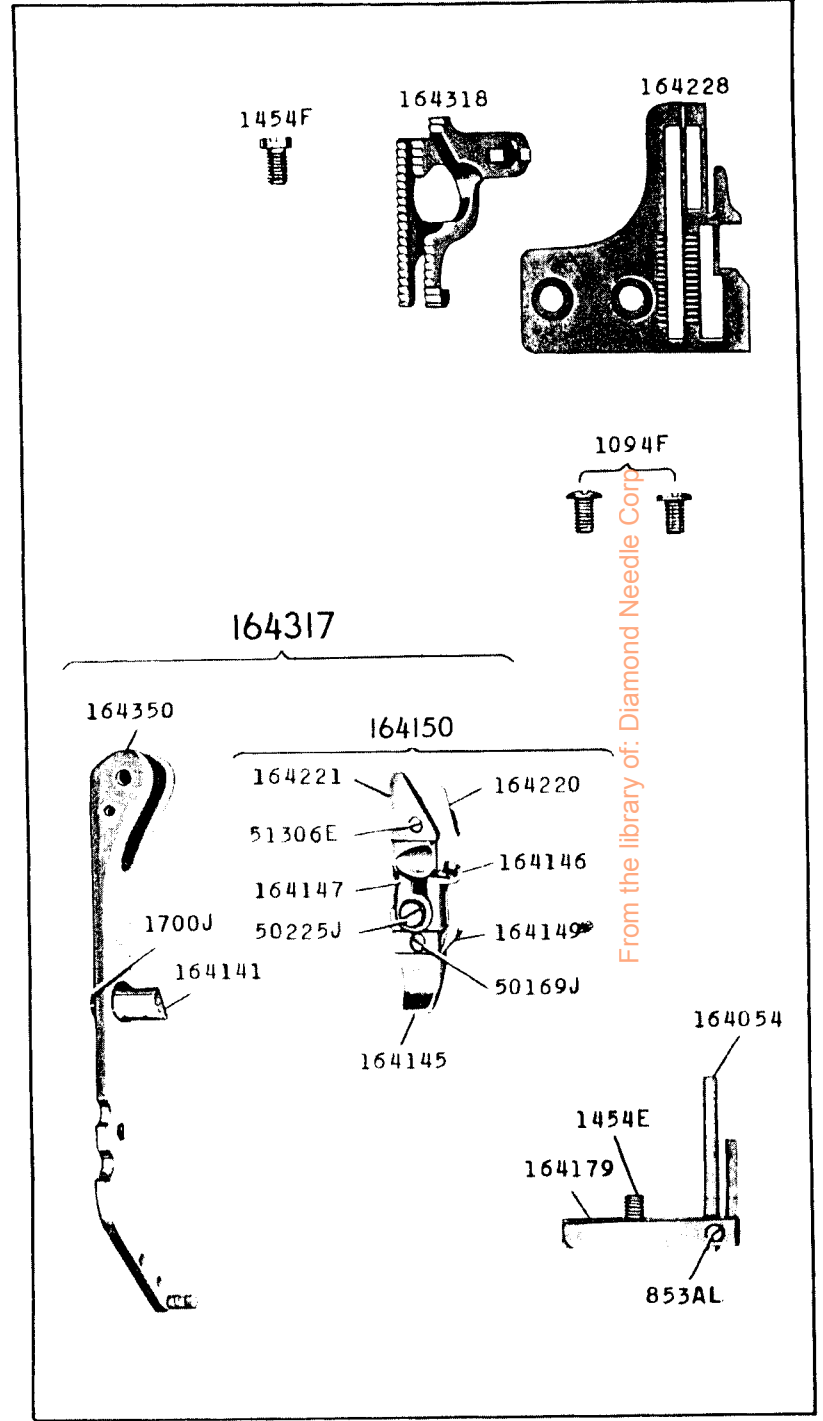



24801 - 1/2

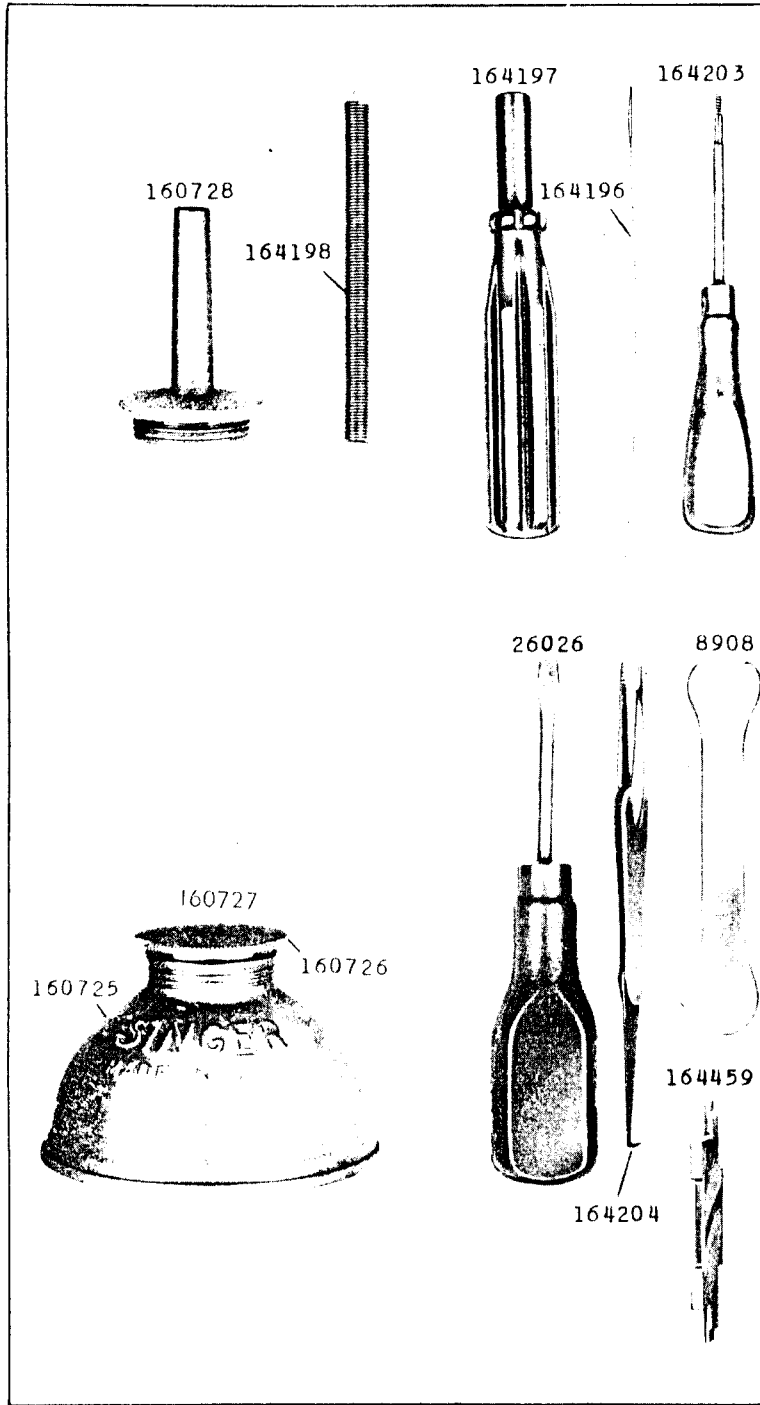

24802 - 2/3

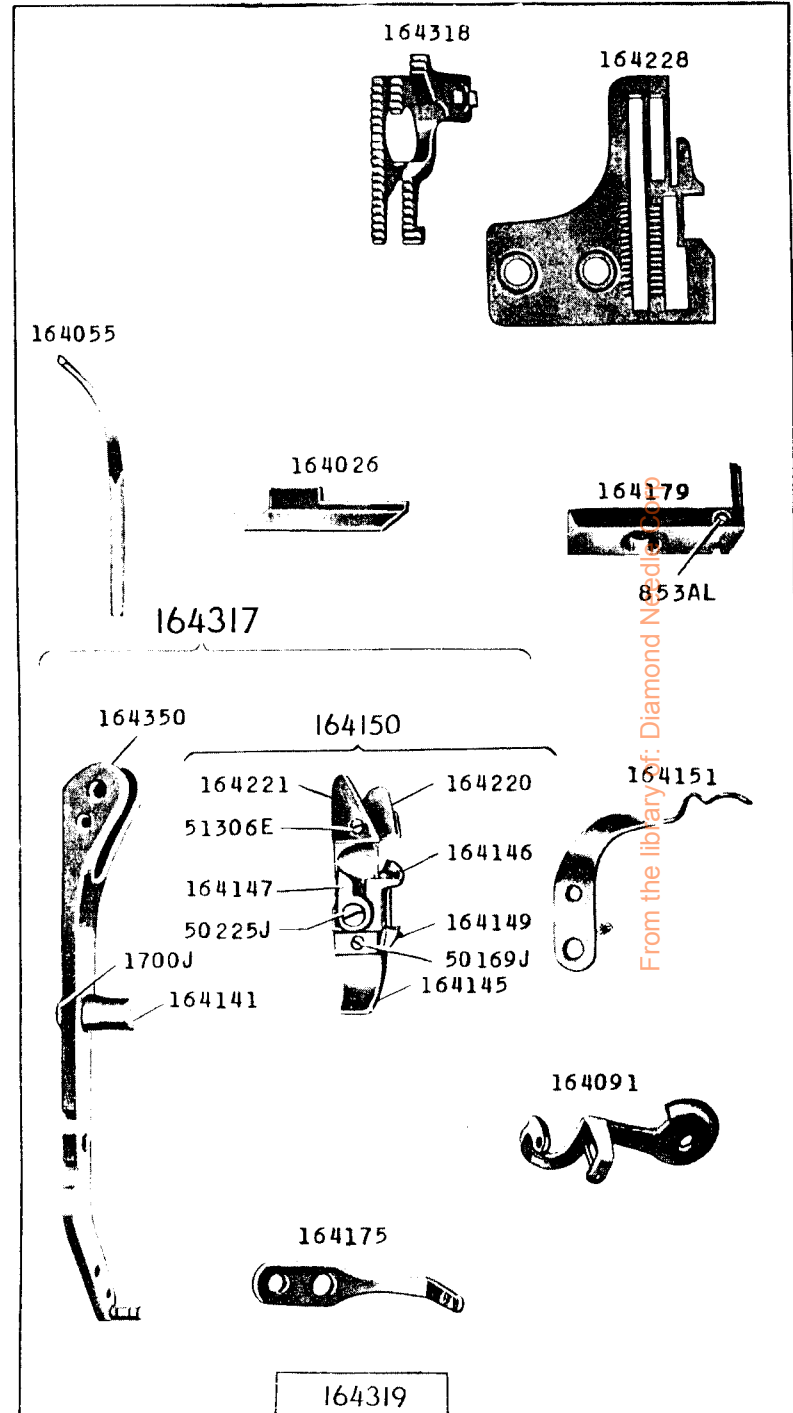

24803 - 2/3

164346

164295



164252



164308



164381

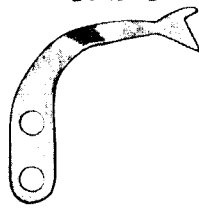

164317

1700J

164350



164150

164221

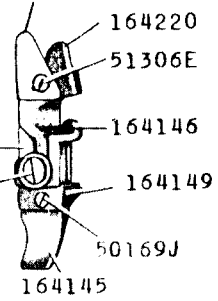

164220

51306E

164146

164149

50169J

164147

50225J

164141

164145

164228

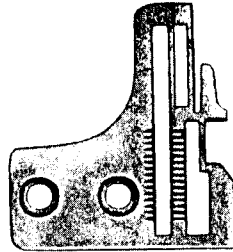

164091

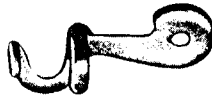

164179



853AL

164175



24804 - 2/3

164387

164290

164281

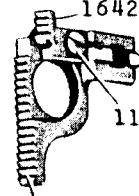

164280

1100AL

164279

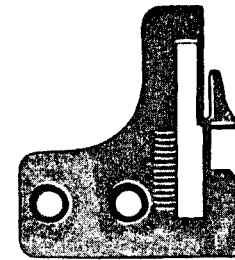

164258



164284

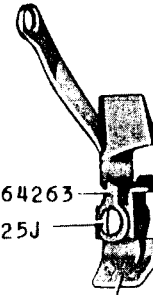

140180J



164263

50225J

164282

164283

164268



853AL

164381



From the library of: Diavolli Needs Corp

164055



164026



164091



164175

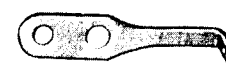

24805 - 1/2

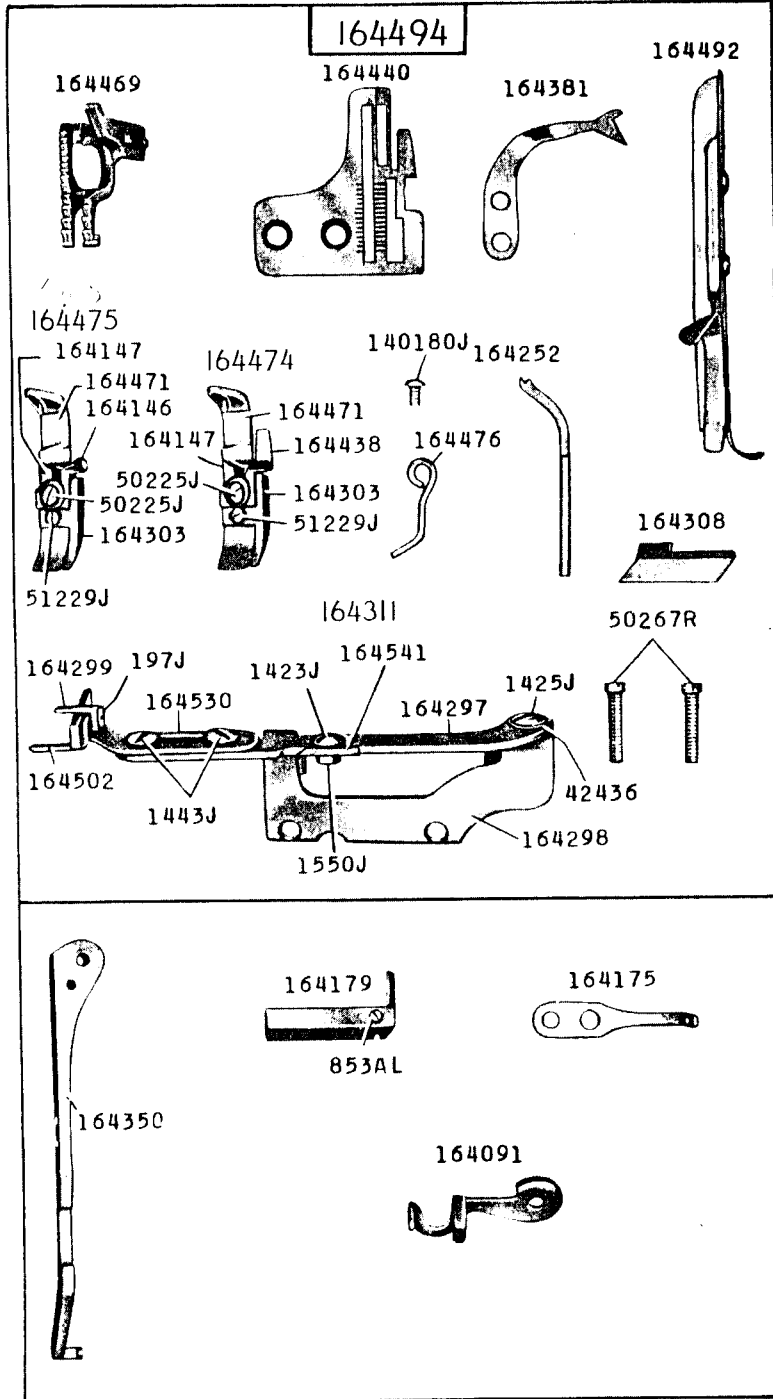

24806 - 1/6

